

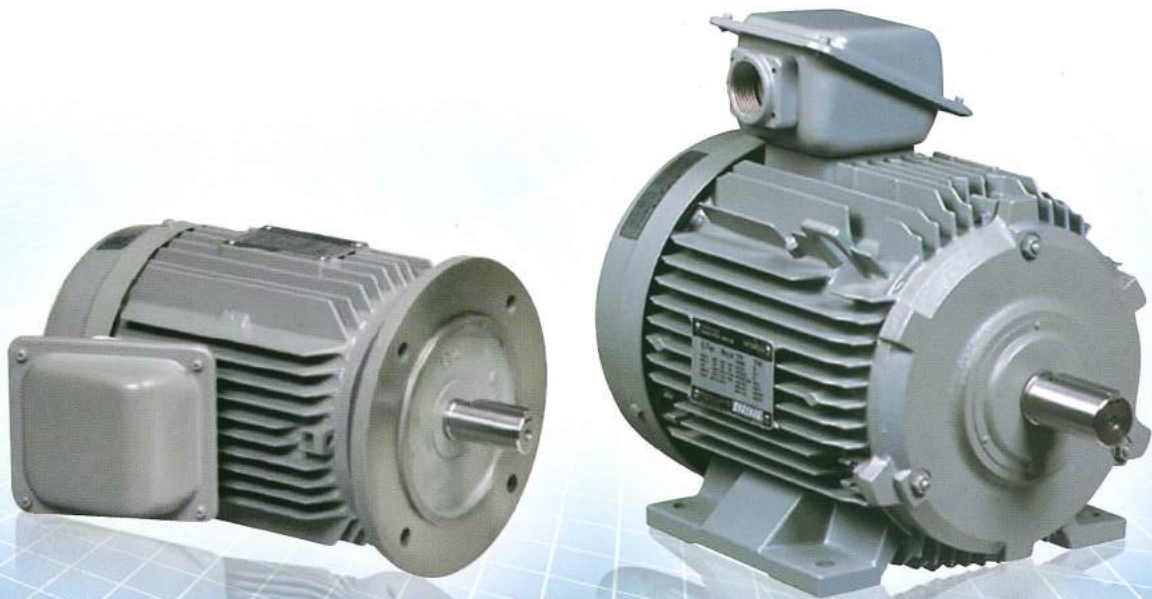

Hitachi Electric Motors For Industrial application

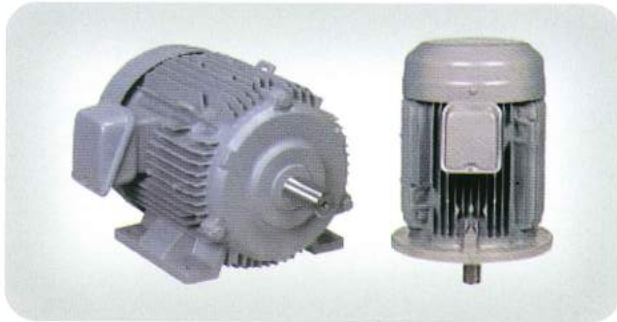

Three-Phase Motors



IP44 Series

Foot / Flange Mount
1/7~175HP (0.1~132kW)
2 / 4 / 6 / 8 pole



IP55 Series

Foot / Flange Mount
1/2~175HP (0.4~132kW)
2 / 4 / 6 / 8 pole

Single-Phase Motors



Split-Phase Start

1/8~1/2HP (0.09~0.75kW)
4 pole



Capacitor Start

1/8~1HP (0.09~0.75kW)
4 pole



Capacitor Start Capacitor Run

1.5~10HP (1.1~7.5kW)
4 pole

Historical transition of Hitachi Motor Development.

Motor Size: 5HP (3.7kW 4P)



Ratio of Weight

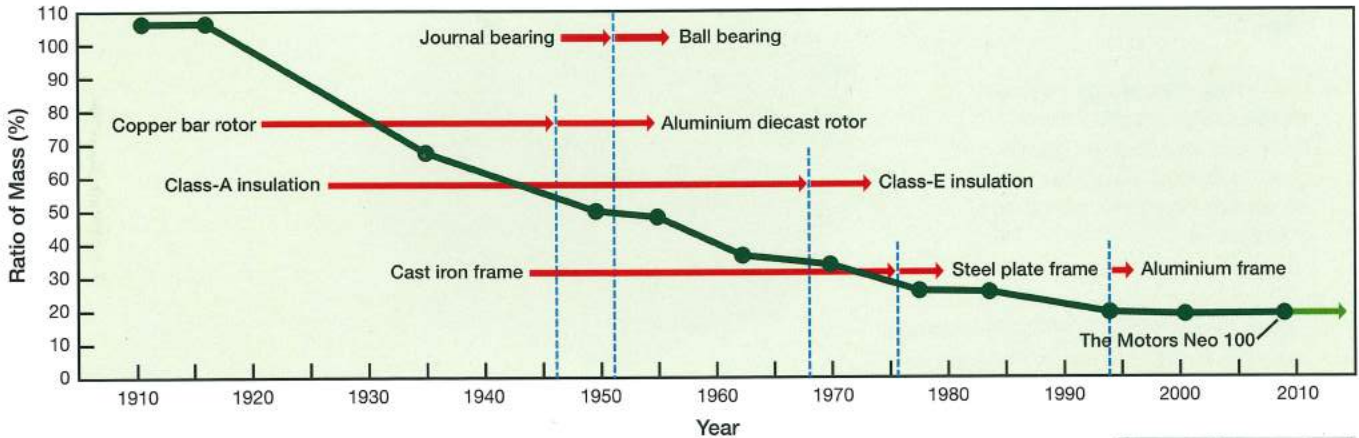

Facilities of Production and Development.



Hitachi Narashino Plant in Japan



Central Research Laboratory



Administrative Division

Production Plant in Thailand.



High performance with latest technologies.

2. The insulated lead-wire has high performance and efficiency.

In our high technology, we developed high quality insulated wire and varnish that can support various hostile environments, even under high temperature.

1. Aluminum-alloy frame is beneficial for light weight.

Aluminum-alloy is used as raw material of motor housing (Used in parts for airplane, shinkansen, etc), which makes the motor to effectively ventilate heat and provides light weight

4. Using high quality bearings also adopted high graded grease.

On of major importance for motor is quality of bearings. The Hitachi motors are used the high quality one with high graded grease.

5. Liquid gasket seal (For IP55 construction)

Using high quality liquid seal for IP55 series in order to establish durability and long life for the motors.

6. End brackets (Front and back) that have a robust construction for strength.

The end brackets are made by cast iron in order to establish robustness for motor construction.

7. Special slot and compact coil effect to lower sound and high performance.

From a start for running, the motor can smoothly start with high torque and reduces a damage for machine because of low vibration. The motor does not harm construction in the motor and the machine.

3. Silent and highest cooling efficiency.

The ventilation process is developed from CAE (Computer Aided Engineering) and has high efficiency fan with quietness. This high quality motor is accomplished through the effective use aluminum alloy.

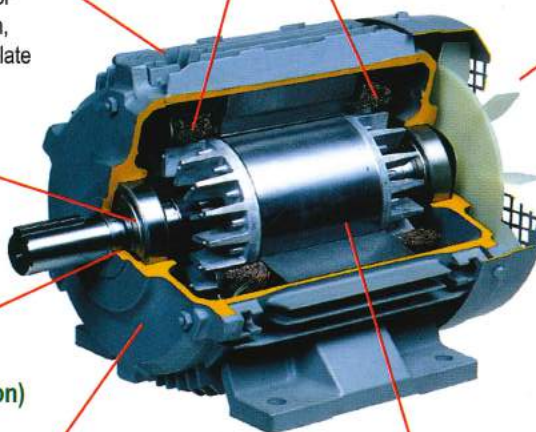

Easy handing on site because of light weight.

Aluminum alloy housing realize light weight.

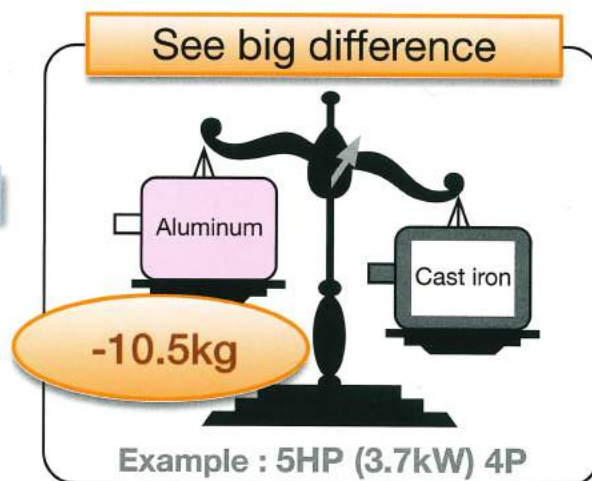
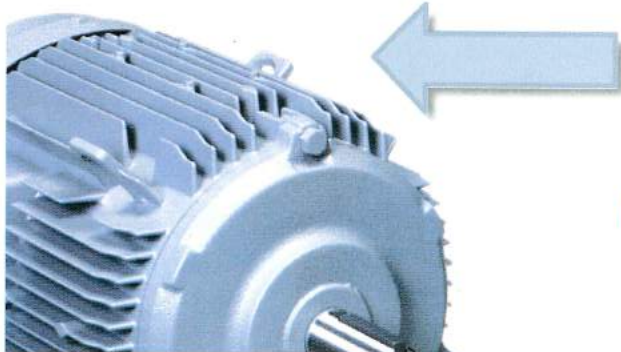

The average weight decreased by 30%

Furthermore technologies on motor design & development.

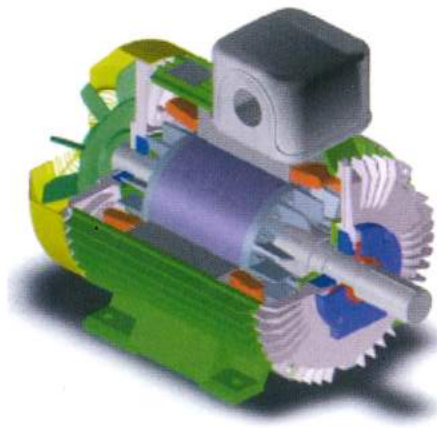
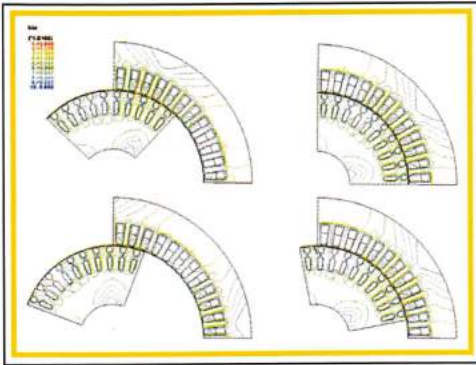

Secret formula of silence is energy

We have researched and found the right vibrational level and calculated the durability of motor structure by computer systems. You can rely upon our high-quality motors. We have also discovered and designed the methods that could reduce high frequency while machines are running in addition, we have planned to utilize brand-new materials with high-precision machines, which pertain technology that could control silence and low vibration. We are proud to present our new technology and have strived to produce products that have the best quality.

Insulated wire system that you can rely on

From lead wires to any insulated wires. we have wisely selected high-quality materials in every step of our production process. We use lead wires, which can tolerate high heat, humidity, and coldness. These lead wires can basically tolerate to any climates with high-quality standards, even when using in a very high temperature

Reliability of high-power torque energy

Hitachi motors have been designed from slot in rotor for aluminum injection, which is a specific technique that provides high-power torque for better start. You can notice from the start to a running period. You would find that Hitachi motor have a very smooth start with an increase in usage capacity.

Energy source Compact-Coil structure

One of our new technologies is Compact Coil. When the Coil is small, It can control all system errors with high capacity. Insulate has a round shape placed parallel to each other in which it to create high conserved energy. As a result, internal structure has an increase in space, which provides a better ventilating system for cooling efficiency.

Hitachi **WR Grease** has capability of tolerating heat four times more than ordinary lithium. The grease can also be operated or tolerated from the highest temperature to the lowest temperature with excellent performance. On the other hand, it can extend the usage life of motors because of shield Bearing technology.

The test result of grease in high temperature

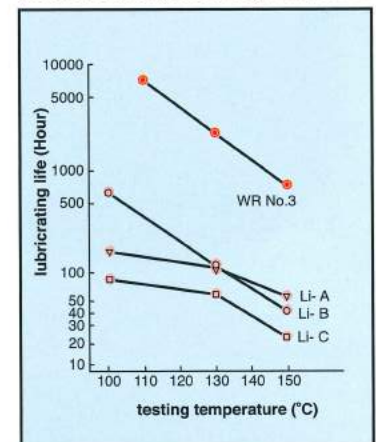

Usage life of lead wires in a heat situation

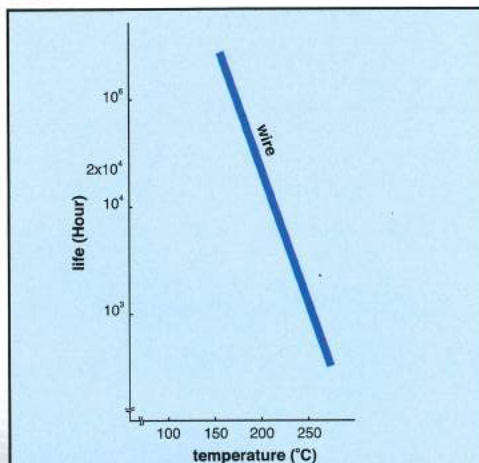

Main Feature for Single-phase motors.

More reliable in various fields.

Economical and High Efficiency

Following IEC standard, insulation class E comes with low vibration level and low noise, which is the advantage of 3-phase motor developed from 1-phase motor of Hitachi. Your satisfaction is guaranteed because it can be used in a variety of industries with high engine performance. We believe in high quality products in which we strictly control our manufacturing process for high quality and performance. Therefore, high engine performance with low vibration level makes our Hitachi motor one of the best and highly satisfies our customers worldwide.

Compact size

Hitachi Motor uses housing-steel iron (state of the art technology used widely), aluminum alloy cover for impact protection, and the modern shape.

Switch works constantly

The centrifugal switch was developed that install to the rotor. It can be guaranteed that the switch will work constantly.

Efficient Ventilation System

We use a high-performance ventilation system that effectively exchanges air from inside to outside environment with dust protection into the centrifugal switch. All of these features contribute to a high performance machine.

High temperature resistance plastic insulator



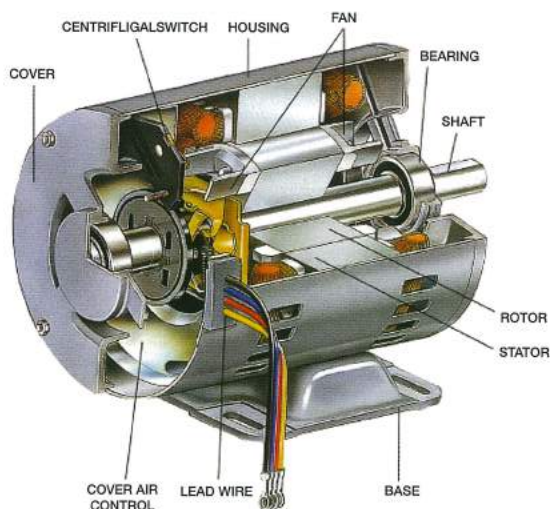
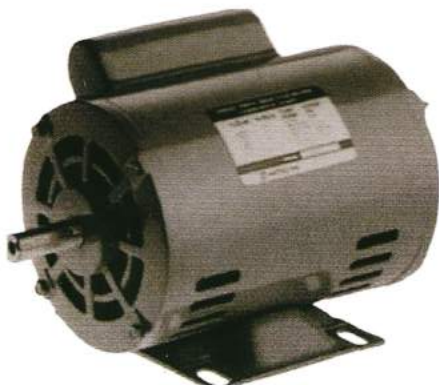

We carefully choose to use plastic insulation that can support high heat, which is one of the components that makes Hitachi Motor one of the safest motor used in industries.



SPECIFICATIONS

ITEM		SPECIFICATION		
STANDARD		JIS C4203, 4034, JEC-2137-2000		
RATING		CONTINUOUS [S1]		
INSULATION CLASS		E TYPE		
ENCLOSURES TYPE PROTECTION		ENCLOSURES		PROTECTION
		TYPE	IP22	
OPEN TYPE	DRIP	EFOU-KT, KR, KQ		
PROOF	EFOUP-KT, KR, KQ			
VOLTAGE FREQUENCY		220V 50Hz		
TYPE OF CABLE		Made from high temperature resistance plastic (end of pole conduct electric current)		
NUMBER OF CABLE		4 WIRES (1/4-1/3 HP-KT, -KR, 2-10 HP-KQ) 3 WIRES (1/2-1.5 HP-KR, KQ)		
COLOR		Rigail gray (MUNSELL 8.9Y5.1/0.3)		
TRANSMISSION		DIRECT COUPLING OR BELT DRIVE		
ROTATION		CW (VIEW FROM MOTOR DRIVE END)		
ENVIRONMENT	TEMPERATURE	-20 °C ~ 40 °C		
	HUMIDITY	Max 90%RH		
	ALTITUDE	Max 1,000 m		
	ESTABLISHMENT	IN DOOR		
ATMOSPHERE		NO CORROSIVE GAS, NO EXPLOSIVE GAS, NO STEAM, NO DEW, LITTLE DUST		

Variety of motor

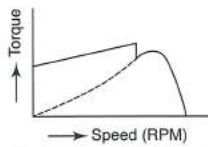
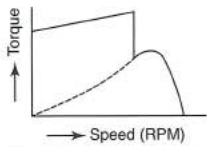
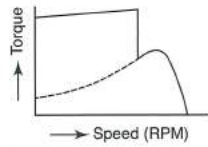
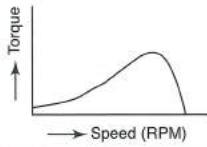
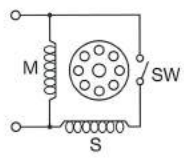
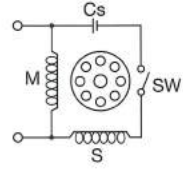
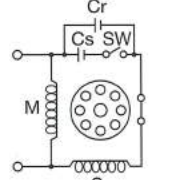
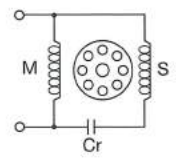
TYPE	SPLIT-PHASE START	CAPACITOR START	CAPACITOR START CAPACITOR RUN	CAPACITOR RUN
MODEL	KT	KR	KQ	KP
APPEARANCE				
CHARACTERISTIC -CURVE				
CONNECTION				
	M : Main Coil S : Starting coil SW : Certrifugal Switch		Gs : Starting Capacitor Cr : Running Capacitor	
FEATURES	Simple Structure	High Starting Torque	High Starting Torque Lower Running Current	Low Starting Torque Lower Running Current
APPLICATION	Drilling Machine Blower	Conveyor Pump	Compressor	Fan

The Wiring Connection and Propelling Direction

1/4HP, 1/3HP-KT

4 LEAD WIRE

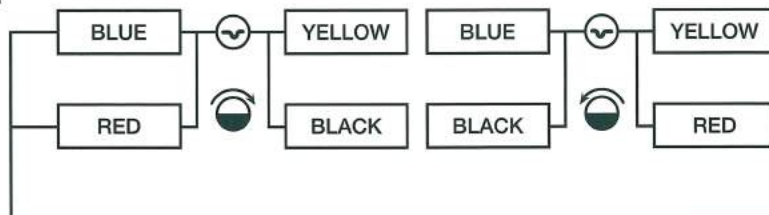

1/2HP-KT - 10HP-KQ

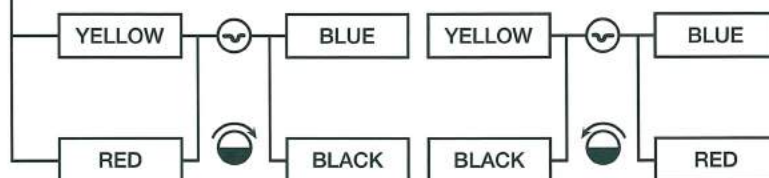

3 LEAD WIRE



Three-phase Motors

Basic Specifications

Item	Specifications		
Standard	JEC-2137-2000, JIS C 4210, 4034, etc.		
Rating	Continuous [S1]		
Insulation Class	2, 4, 6 Pole (8 Pole for some range)		
		B Type	~180 M
		F Type	180 L~
Enclosures Type	Enclosures		Type Protection
	Indoor	Fan cooled type Vertical Fan cooled type	TFO-K, KK VTFO-K, KK IP44
Protection	Outdoor	Fan cooled type Vertical Fan cooled type	TFO-K, KK VTFO-K, KK IP55
Voltage, Frequency	1/2 ~ 5 HP : 220/380V 50Hz 7.5HP ~ : 380/415V 50Hz		
Number of Cable	~ 5 HP 6 Wires (Direct starting 220V or 380V)		
	7.5 HP ~ 6 Wires (Star λ - Δ Delta starting)		
	2 pole 30 HP ~ 4 pole 40 HP ~ 6 pole 50 HP ~	12 Wires (Star λ - Δ Delta starting)	
Color	Alcron gray		
Transmission	2 pole 15 HP ~ Direct coupling 2 pole 10 HP and 4 pole ~ Direct coupling or Belt drive		
Rotation	CCW (View from motor drive end)		
Environment	Temperature	-30 ~ 40°C	
	Humidity Altitude Establishment	Enclosed type Max 95% RH Max 1,000 m [IP44] Indoor type, [IP44 Special, IP55] Outdoor type	
Atmosphere	No corrosive gas, No explosive gas, No Steam, No dew, little dust		

Nameplate on motors

Model : CE Version

THREE PHASE INDUCTION MOTOR		HITACHI	
MODEL : TFO-K (TFOD-112M)-4P		RATING	S1
5 HP	4 POLE	TH. CLASS	F
VOLTS	220 380	AMB. TEMP.	40 °C
HERTZ	50 50	PROTECTION	IP55
AMP'S	13.8 8.0	COOLING	IC411
RPM	1410 1410	BRG. D. S.	6306ZZ
STANDARD	EN 60034-1	BRG. O. S.	6306ZZ
		WEIGHT	28 kg.
Hitachi Industrial Technology (Thailand), Ltd.		MFG. No.	205830

The Wiring Connection and Propelling Direction

Circuit Diagram for the use of motor wiring connection

6-wire 220/380V

Connect to power source to start-up

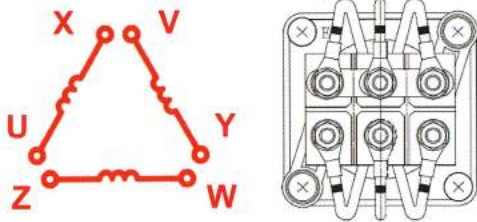

Direct on Line Start

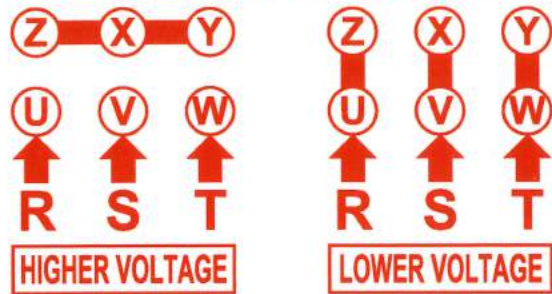

6-wire 380/415V

Connect to power source to start-up or Star-Delta

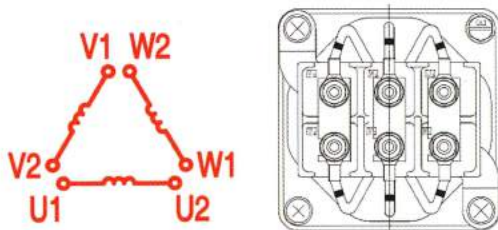

Direct on Line Start

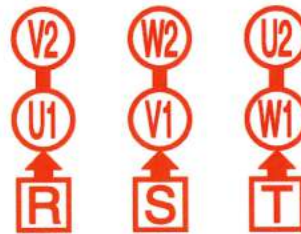

Star-Delta Start

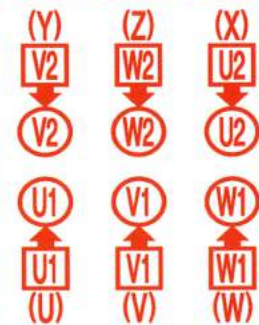

12-wire 200/380/400V

Connect to power source to start-up or Star-Delta

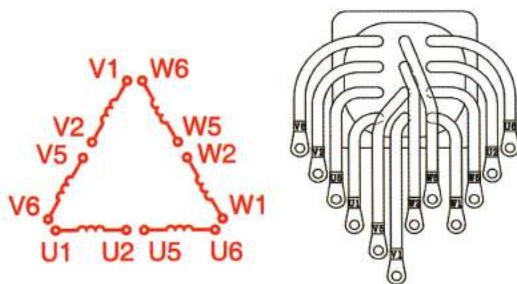

Direct on Line Start

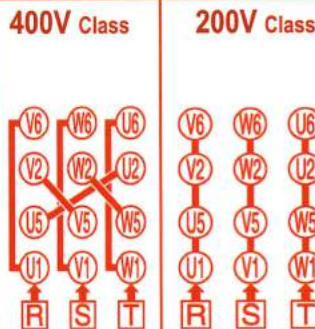

Star-Delta Start

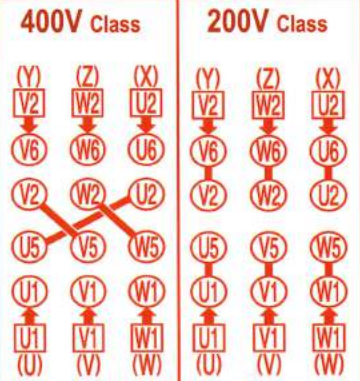

Rotation

COUNTER CLOCK WISE
(Hitachi Standard)



CLOCK WISE

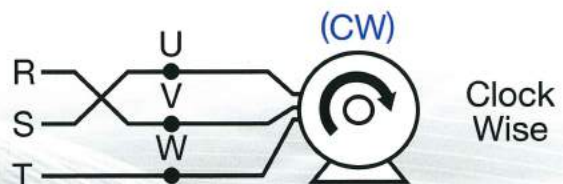
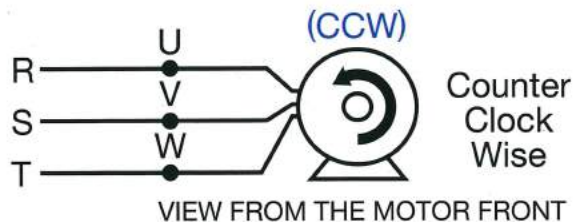

High-Efficiency Motors / IE3 class

Main Features :

1. Global standard

- Conformity to JIS C 4213 (Japan) [Efficiency class: IEC60034-30 Premium efficiency class (IE3)]

2. High-efficiency

- Compare to the standard motors, iron core shape is improved and material quality is raised
- Motor loss is reduced 30~40%
- This improvement realizes higher efficiency when compared with the standard motors

3. Long motor life

- The temperature of stator coil has been decreased at 10~20°C under a rationalization design and a high cooling effect for an electric part
- The coil insulation is achieved two times longer on operation life compared with the standard motor
- The bearings are also 2.5 times longer on operation life
- The operation life changes depending on operation conditions

4. Inverter operation is also available (1:10 or 1:20 constant torque)

- 0.4~1.5kW 4P is available to operate with 1:10 (6~60Hz) speed under 100% constant torque operation using the inverters (In case the sensorless vector inverters are used) 1:20 (3~60Hz) is also available with special design motors. These motors are adopted durable insulation system with advanced technology.

5. Furthermore benefit

- Low noise and vibration can be realized with advanced technologies

6. Operational cost saving

- Considering the operational cost under long term period, the best idea is to adopt the high efficiency motors
- The point is just not to consider the initial cost of motor but overall cost including long term operation

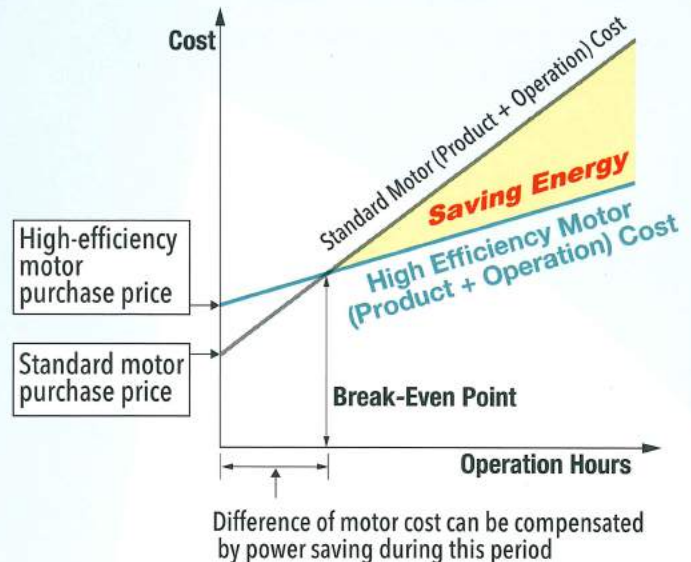
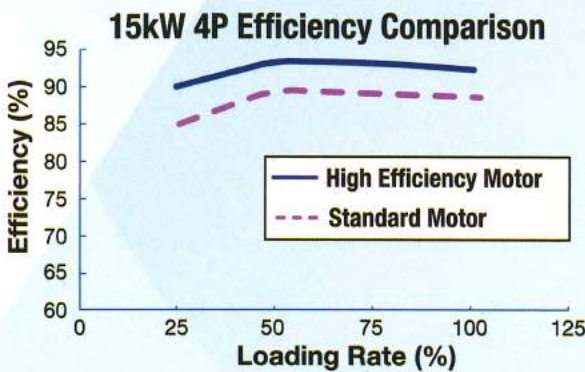

• The annual energy savings with high efficiency motor can be estimated by following formula

$$\text{The annual saving fee} = \text{Output (kW)} \times \text{Operation hour (hour / year)} \times \text{Power charge cost (Cost / kWh)} \times \left[\frac{100}{\text{Standard Motor efficiency (\%)}} - \frac{100}{\text{High efficiency motor efficiency (\%)}} \right]$$

High efficiency motor saves energy consumption in proportion to operating hour.

Sample calculation

Motor output : 15kW
 High-efficiency motor efficiency : 93.0%
 Standard motor efficiency : 88.5%
 Annual operation hours : 4,800hours (16h/day)
 Electric power rate : US\$0.15/kWh

Annual energy saving
 Approx. US\$590.49

Basic Specifications

Efficiency class

IE3 Premium Efficiency ←

IE2 High Efficiency

IE1 Standard



Item		Specifications
Standard		JIS C 4213 (Efficiency classes: JIS C 4034-30:2011 Premium efficiency class (IE3))
Construction		Totally enclosed fan-cooled types (Indoor and outdoor types)
Model	Foot mount	Indoor type TFO-LK (0.75~3.7kW), TFO-LKK (5.5kW~)
		Outdoor type TFOA-LK (0.75~3.7kW), TFOA-LKK (5.5kW~)
	Flange mount	Indoor type VTFO-LK (0.75~3.7kW), VTFO-LKK (5.5kW~)
		Outdoor type VTFOA-LK (0.75~3.7kW), VTFOA-LKK (5.5kW~)
Output	2 Poles	0.75~132kW
	4 Poles	0.75~132kW
	6 Poles	0.75~110kW
Heat-resistant class		155(F) ※ 1
Rating		S1 (Continuous)
Protection		Indoor types : IP44 Outdoor types : IP55
Voltage / Frequency		220/380V or 380/415V 50Hz 2 Poles 22kW~, 4 Poles 18.5kW~, 6 Poles 15kW~200V 50/60Hz, 220/230V 60Hz 400V 50/60Hz, 440/460V 60Hz
Lead wire construction		Lug connection : 2 Poles 22kW~, 4 Poles 18.5kW~, 6 Poles 15kW~ ※ 5.5kW~ Available Y - Δ starting
Number of lead wires		6 : (5.5kW~) 12 : 2 Poles 22kW~, 4 Poles 18.5kW~, 6 Poles 15kW~
Painting color		Rigail gray (munsell 8.9Y 5.1/0.3)
Transmission system		2 Poles 11kW~ : Direct coupling only 2 Poles~7.5kW and all of 4 Poles~ : Direct or belt coupling
Rotation		Clockwise when viewed from the anti-load side
Environment	Temperature	-30~40°C
	Humidity	95%RH or less
	Altitude	1,000m or less
Atmosphere		No corrosive gas, no explosive gas, no steam, no dew condensation, and little dust

Note : Request a dimensional drawing to us for design use because the specifications may be subject to change.
 ※ 1 Temperature rise : Frame size 112M or less class E, Frame size 132S~180M class B

Production Plant

Prachinburi, Thailand



Narashino, Japan



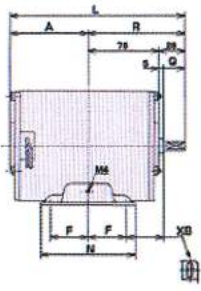

Fig.1

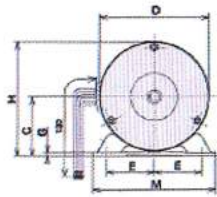

Fig.2

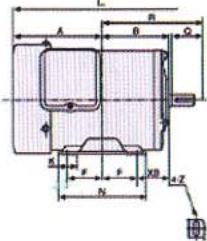

Fig.3

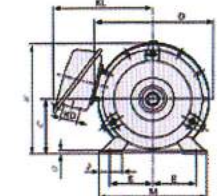

Fig.4

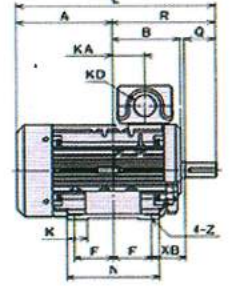

Fig.5

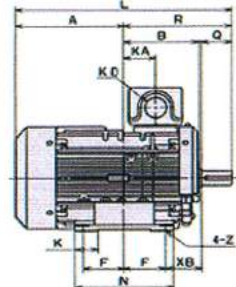

Fig.6

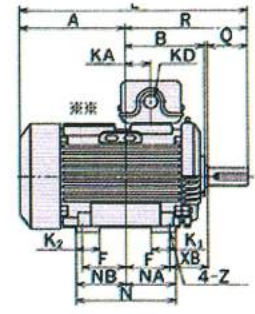
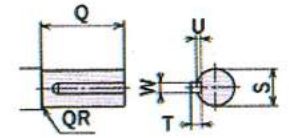
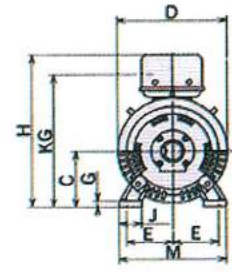

Fig.7



Shaft Dimension

Dimension in mm									Bearing No.		Approx Weight (kg)			Approx Packing Dimension (cm)
G	Z	XB	S	W	U	T	Q	QR	Drive End Side	Opposite Side	2 Pole	4 Pole	6 Pole	H x W x L
3.2	7x21	40	14 ⁺⁰ _{-0.011}	-	1	-	23	-	6202ZZ	6202ZZ	-	5	-	14.5 x 15 x 26
3.2	7x21	40	14 ⁺⁰ _{-0.011}	-	1	-	23	-	6202ZZ	6202ZZ	-	5.5	-	14.5 x 15 x 26
3.2	7x20	45	14 ^{+0.008} _{-0.003}	5	3	5	30	1	6203ZZ	6203ZZ	9.5	8.2	-	16 x 22 x 27
3.2	10x25	50	19 ^{+0.009} _{-0.004}	6	3.5	6	40	0.3	6204ZZ	6204ZZ	13.5	12.5	16	18 x 24 x 31
10	10	56	24 ^{+0.009} _{-0.004}	8	4	7	50	0.3	6205ZZ	6205ZZ	15 16	16	16	20 x 27 x 37
12.5	12	63	28 ^{+0.009} _{-0.004}	8	4	7	60	0.5	6206ZZ	6206ZZ	-	21	23	25 x 29 x 39
14	12	70	28 ^{+0.009} _{-0.004}	8	4	7	60	0.5	6306ZZ	6306ZZ	27.5	28	30	27 x 32 x 41
16	12	89	38 ^{+0.018} _{+0.002}	10	5	8	80	0.5	6308ZZ	6306ZZ	39 44	40	41	34.2 x 45.5 x 57.5
16	12	89	38 ^{+0.018} _{+0.002}	10	5	8	80	0.5	6308ZZ	6306ZZ	-	48	52	34.2 x 45.5 x 57.5
18	14.5	108	42 ^{+0.018} _{+0.002}	12	5	8	110	1	6309ZZ	6307ZZ	70 79	73	75	39 x 51 x 72.5
18	14.5	108	42 ^{+0.018} _{+0.002}	12	5	8	110	1	6309ZZ	6307ZZ	85	85	90	39 x 51 x 72.5
20	14.5	121	48 ^{+0.018} _{+0.002}	14	5.5	9	110	1.5	6311ZZ	6309ZZ	115	120 130	130	53 x 60 x 73
20	14.5	121	55 ^{+0.030} _{+0.011}	16	6	10	110	1.5	6312ZZ	6309ZZ	140	155	150 160	64 x 45 x 86
23	18.5	133	55 ^{+0.030} _{+0.011} 60 ^{+0.020} _{+0.011}	(16) 18	(6) 7	(10) 11	(110) 140	(-) 1.5	(6312) 6313ZZ	(6312ZZ) 6312ZZ	200 210	210 230	220 240	67 x 50 x 91
23	18.5	149	(55 ^{+0.030} _{+0.011}) 65 ^{+0.030} _{+0.011}	(16) 18	(6) 7	(10) 11	(110) 140	(-) 2.5	(6312) 6315ZZ	(6312ZZ) 6312ZZ	235	260	265	72 x 56 x 96
30	24	168	(55 ^{+0.030} _{+0.011}) 75 ^{+0.030} _{+0.011}	(16) 20	(6) 7.5	(10) 12	(110) 140	-	(6313C3) NU316	(6313C3) 6313ZZ	430	450	420	84 x 63 x 108
30	24	168	(55 ^{+0.030} _{+0.011}) 75 ^{+0.030} _{+0.011}	(16) 20	(6) 7.5	(10) 12	(110) 140	-	(6313C3) NU316	(6313C3) 6313ZZ	450	515	500	84 x 63 x 108
30	24	190	(55 ^{+0.030} _{+0.011}) 85 ^{+0.030} _{+0.011}	(16) 22	(6) 9	(10) 14	(110) 170	-	(6313C3) NU318	(6313C3) 6315ZZ	615	625	630	94 x 70 x 123
30	24	190	(55 ^{+0.030} _{+0.011}) 85 ^{+0.030} _{+0.011}	(16) 22	(6) 9	(10) 14	(110) 170	-	(6313C3) NU318	(6313C3) 6315ZZ	630	680	720	94 x 70 x 123
28	28	216	95 ^{+0.035} _{+0.013}	25	9	14	170	-	NU320	6318	-	-	930	97 x 73 x 134

Three-Phase Induction Motors

Totally Enclosed Fan-Cooled Type (TEFC)

IP55 Series / Foot Mount Type [TFO-K(KK)]

1/7~180HP (0.1~132kW) / Left terminal box position (upto 180M)



Model:

xxHP or kW TFO-K(KK) xP IP55 TML

Output

No of pole

Item	Specifications	
Motor Output	1/7~180HP (0.1~132kW)	
Rating	Continuous [S1]	
Number of pole	2, 4, 6 pole	
Insulation Class	F type	
Enclosure	IP55 (Outdoor use)	
Voltage, Frequency	Consult to nearest representative	
Number of Cable	~5 HP 6 Wires (Direct starting 220V or 380V)	
	7.5 HP ~ 6 Wires (Star Δ - Δ Delta Starting)	
	2 pole 30 HP ~	12 Wires (Star Δ - Δ Delta Starting)
	4 pole 40 HP ~	
	6 pole 50 HP ~	
Color	Alcron gray (MUNSAELL 8.9Y5.1/0.3)	
Rotation	CCW (View from motor drive end)	
Environment	Temperature Humidity Altitude	
	-30 ~ 40 °C Enclosed type Max 95% RH Max 1,000 m	

Type From	Frame size	Output (HP)			Insulation	Fig. No	Dimension in mm										
		2 Pole	4 Pole	6 Pole			L	R	A	B	D	KL	KD	K	J	H	C
TO-K	63M	-	1/7	-	B	1	212	103	109	78.5	116	125	PF1/2	25	25	134.5	63 $\frac{0}{-0.5}$
	63M	-	1/4	-	B	1	212	103	109	78.5	116	125	PF1/2	25	25	134.5	63 $\frac{0}{-0.5}$
TFO-K	71M	1/2	1/2	-	B	2	236	120	116	87	145	158	PF3/4	25	30	164	71 $\frac{0}{-0.5}$
	80M	1	1	1/2	B	2	268.5	140	128.5	97	163	166	PF3/4	25	35	175	80 $\frac{0}{-0.5}$
	90L	$\frac{2}{3}$	2	1	B	3	315	168.5	146.5	116	180	168	PF3/4	49	35.5	180	90 $\frac{0}{-0.5}$
	100L	-	3	2	B	3	356	193	163	130.5	199	176	PF 1	51.5	45	199.5	100 $\frac{0}{-0.5}$
	112M	5	5	3	B	3	372	200	172	137.5	223	190	PF 1	51.5	45	223.5	112 $\frac{0}{-0.5}$
TFO-KK	132S	$\frac{7.5}{10}$	7.5	5	B	4	427.5	239	188.5	153	250	234	PF1 $\frac{1}{4}$	56	50	257	132 $\frac{0}{-0.5}$
	132M	-	10	7.5	B	4	465.5	258	207.5	172	250	234	PF1 $\frac{1}{4}$	56	50	257	132 $\frac{0}{-0.5}$
	160M	$\frac{15}{20}$	15	10	B	4	595	323	272	198	292	260	PF1 $\frac{1}{2}$	107	60	303.5	160 $\frac{0}{-0.5}$
	160L	25	20	15	B	4	595	345	250	220	292	260	PF1 $\frac{1}{2}$	107	60	303.5	160 $\frac{0}{-0.5}$
	180M	30	$\frac{25}{30}$	20	B	4	643	351.5	291.5	226.5	340	283	PF 2	75	90	350	180 $\frac{0}{-0.5}$
TFO-KK	180L	40	40	$\frac{25}{30}$	F	5	716	370.5	345.5	245.5	340	-	PF2 $\frac{1}{2}$	75	90	494	180 $\frac{0}{-0.5}$
	(200LB) 200L	50 60	50 60	40 50	F	(6) 5	(790) 820	(395.5) 425.5	394.5	(276.5) 270.5	391	-	PF2 $\frac{1}{2}$	85	110	541.5	200 $\frac{0}{-0.5}$
	(225SB) 225S	75	75	60	F	(6) 5	(826.5) 856.5	(402) 432	424.5	(283) 270.5	391	-	PF2 $\frac{1}{2}$	85	110	566.5	225 $\frac{0}{-0.5}$
	(250SD) 250S	100	100	75	F	6	(909) 939	(433.5) 463.5	475.5	(313.5) 312.5	490	-	PF2 $\frac{1}{2}$	-	100	735	250 $\frac{0}{-0.5}$
	(250MD) 250M	120	120	100	F	6	(909) 939	(452.5) 482.5	456.5	(332.5) 331.5	490	-	PF2 $\frac{1}{2}$	-	100	735	250 $\frac{0}{-0.5}$
	(280SD) 280S	150	150	120	F	6	(1008) 1068	(484) 544	524	(364) 363	550	-	PF 3	-	100	795	280 $\frac{0}{-1.0}$
	(280MD) 280M	180	180	150	F	6	(1008) 1068	(509.5) 569.5	498.5	(389.5) 388.5	550	-	PF 3	-	100	795	280 $\frac{0}{-1.0}$
	315S	-	-	180	F	6	1178	589	589	408	633	-	PF 3	-	125	865	315 $\frac{0}{-1.0}$

() : 2 pole Motor

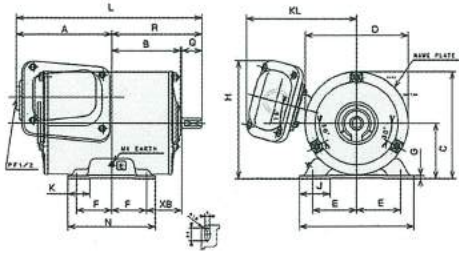

Fig.1

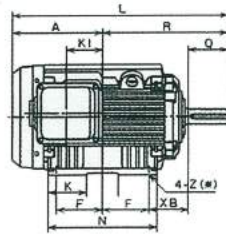

Fig.4

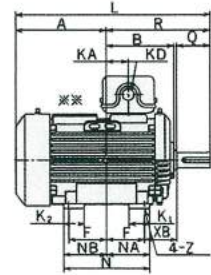

Fig.6

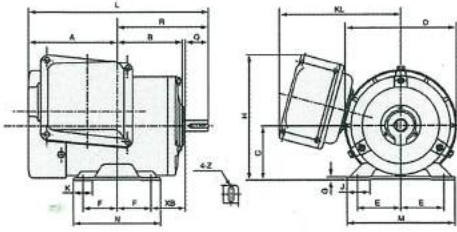

Fig.2

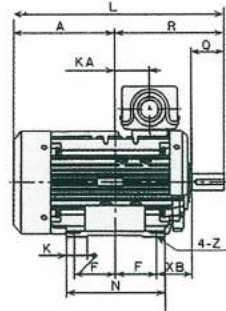

Fig.5

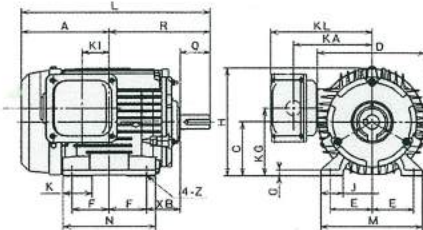
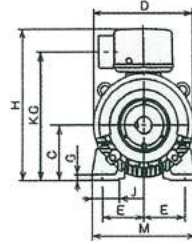
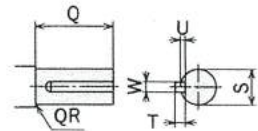

Fig.3



Shaft Dimension

Dimension in mm													Approx Weight (kg)			Approx Packing Dimension (cm)
F	E	N	M	G	Z	XB	S	W	U	T	Q	QR	2 Pole	4 Pole	6 Pole	H x W x L
40	50	100	130	3.2	7x21	40	11 ^{-0.011}	-	1	-	23	1.5	8	8.5	-	
40	50	100	130	3.2	7x21	40	11 ^{-0.011}	-	1	-	23	1.5	8	8.5	-	
45	56	115	140	3.2	7x20	45	14 ^{+0.008/-0.003}	5	3	5	30	1.0	8	8.5	-	16 x 22 x 27
50	62.5	125	160	3.2	10x25	50	19 ^{+0.009/-0.004}	6	3.5	6	40	0.3	10	12	12	18 x 24 x 31
62.5	70	155	170	10	10	56	24 ^{+0.009/-0.004}	8	4	7	50	0.3	15 16	16	16	20 x 27 x 37
70	80	175	195	12.5	12	63	28 ^{+0.009/-0.004}	8	4	7	60	0.5	-	21	23	25 x 29 x 39
70	95	175	224	14	12	70	28 ^{+0.009/-0.004}	8	4	7	60	0.5	27.5	28	30	27 x 32 x 41
70	108	175	250	16	12	89	38 ^{+0.018/+0.002}	10	5	8	80	0.5	39 44	40	41	34.2 x 45.5 x 57.5
89	108	212	250	16	12	89	38 ^{+0.018/+0.002}	10	5	8	80	0.5	-	48	52	34.2 x 45.5 x 57.5
105	127	300	300	18	14.5	108	42 ^{+0.018/+0.002}	12	5	8	110	1	70 79	73	75	39 x 51 x 72.5
127	127	300	300	18	14.5	108	42 ^{+0.018/+0.002}	12	5	8	110	1	85	85	90	39 x 51 x 72.5
120.5	139.5	300	350	20	14.5	121	48 ^{+0.018/+0.002}	14	5.5	9	110	1.5	115	120 130	130	53 x 60 x 73
139.5	139.5	335	350	20	14.5	121	55 ^{+0.030/+0.011}	16	6	10	110	1.5	140	155	150 160	64 x 45 x 86
152.5	159	365	400	23	18.5	133	(55 ^{+0.030/+0.011}) 60 ^{+0.030/+0.011}	(16) 18	(6) 7	(10) 11	(110) 140	(-) 1.5	200 210	210 230	220 240	67 x 50 x 91
143	178	350	450	23	18.5	149	(55 ^{+0.030/+0.011}) 65 ^{+0.030/+0.011}	(16) 18	(6) 7	(10) 11	(110) 140	(-) 2.5	235	260	265	72 x 56 x 96
155.5	203	428	500	30	24	168	(55 ^{+0.030/+0.011}) 75 ^{+0.030/+0.011}	(16) 20	(6) 7.5	(10) 12	(110) 140	-	430	450	420	84 x 63 x 108
174.5	203	428	500	30	24	168	(55 ^{+0.030/+0.011}) 75 ^{+0.030/+0.011}	(16) 20	(6) 7.5	(10) 12	(110) 140	-	450	515	500	84 x 63 x 108
184	228.5	501	550	30	24	190	(55 ^{+0.030/+0.011}) 85 ^{+0.030/+0.011}	(16) 22	(6) 9	(10) 14	(110) 170	-	610	625	630	94 x 70 x 123
209.5	228.5	501	550	30	24	190	(55 ^{+0.030/+0.011}) 85 ^{+0.030/+0.011}	(16) 22	(6) 9	(10) 14	(110) 170	-	630	680	720	94 x 70 x 123
203	254	540	615	28	28	216	95 ^{+0.035/+0.013}	25	9	14	170	-	-	-	930	97 x 73 x 134

Three-Phase Induction Motors

Totally Enclosed Fan-Cooled Type (TEFC)
IP55 Series / Foot Mount Type [TFO-K(KK)]
1/2~180HP (0.4~132kW)



Model:

xxHP or kW TFO-K(KK) xP IP55 TMU

Output

No of pole

Item	Specifications	
Motor Output	1/2~180HP (0.4~132kW)	
Rating	Continuous [S1]	
Number of pole	2, 4, 6 pole [8 Pole : only some range]	
Insulation Class	F Type	
Enclosure	IP55 (Outdoor use)	
Voltage, Frequency	Consult to nearest representative	
Number of Cable	~5HP : 6 Wires (Direct starting 220V or 380V)	
	7.5 HP ~ : 6 Wires (Star Δ - Δ Delta Starting)	
	2 pole 30 HP ~ 4 pole 40 HP ~ 6 pole 50 HP ~	12 Wires (Star Δ - Δ Delta Starting)
Color	Alcron gray	
Rotation	CCW (View from motor drive end)	
Environment	Temperature Humidity Altitude	-30 ~ 40°C Enclosed type Max 95% RH Max 1,000 m

DIMENSIONS (in mm)

Type From	Frame size	Output (HP)			Insulation	Fig. No	Dimension in mm											
		2 Pole	4 Pole	6 Pole			L	R	A	B	D	KD	K	J	H	C	F	E
TFO-K	71M	1/2	1/2	-	F	1	239	120	119	90	145	PF 3/4	25	30	225	71 $_{-0.5}^{0}$	45	56
	80M	1	1	1/2	F	1	271.5	140	131.5	100	163	PF 3/4	25	35	240	80 $_{-0.5}^{0}$	50	62.5
	90L	$\frac{2}{3}$	2	1	F	2	320	168.5	151.5	118.5	180	PF 3/4	49	35.5	258	90 $_{-0.5}^{0}$	62.5	70
	100L	-	3	2	F	2	361	193	168	133	199	PF 1	51.5	45	258	100 $_{-0.5}^{0}$	70	80
	112M	5	5	3	F	2	377	200	177	140	223	PF 1	51.5	45	301	112 $_{-0.5}^{0}$	70	95
TFO-KK	132S	$\frac{7.5}{10}$	7.5	5	F	3	431.5	239	192.5	158	252	PF 1 1/4	56	50	359.5	132 $_{-0.5}^{0}$	70	108
	132M	-	10	7.5	F	3	469.5	258	211.5	177	252	PF 1 1/4	56	50	359.5	132 $_{-0.5}^{0}$	89	108
	160M	$\frac{15}{20}$	15	10	F	3	599	323	276	213	292	PF 1 1/2	107	60	413.5	160 $_{-0.5}^{0}$	105	127
	160L	25	20	15	F	3	599	345	254	225	292	PF 1 1/2	107	60	413.5	160 $_{-0.5}^{0}$	127	127
	180M	25	$\frac{25}{30}$	20	F	4	644	348.5	295.5	238.5	340	PF 1 1/2	75	90	462	180 $_{-0.5}^{0}$	120.5	139.5
TFO-KK	180L	40	40	$\frac{25}{30}$	F	5	717	367.5	349.5	257.5	340	PF 1 1/2	75	90	494	180 $_{-0.5}^{0}$	139.5	139.5
	(200LB) 200L	50 60	50 60	40	F	5	(794) 824	(395.5) 425.5	398.5	(276.5) 285.5	389.2	PF 2 1/2	85	110	541.5	200 $_{-0.5}^{0}$	152.5	159
	(225SB) 225S	75	75	50 60	F	5	(830.5) 860.5	(402) 432	428.5	(283) 285.5	389.2	PF 2 1/2	85	110	566.5	225 $_{-0.5}^{0}$	143	178
	(250SD) 250S	100	100	75	F	6	(913) 943	(433.5) 463.5	479.5	(313.5) 312.5	520	PF 2 1/2	-	100	745	250 $_{-0.5}^{0}$	155.5	203
	(250MD) 250M	120	120	100	F	6	(913) 943	(452.5) 482.5	460.5	(332.5) 331.5	520	PF 2 1/2	-	100	745	250 $_{-0.5}^{0}$	174.5	203
	(280SD) 280S	150	150	120	F	6	(1016) 1072	(484) 544	(532) 528	(364) 363	575	PF 3	-	100	805	280 $_{-1.0}^{0}$	184	228.5
	(280MD) 280M	180	180	150	F	6	(1016) 1072	(507.5) 569.5	(508.5) 502.5	(389.5) 388.5	575	PF 3	-	100	805	280 $_{-1.0}^{0}$	209.5	228.5
	315S	-	-	180	F	6	1182	589	593	408	633	PF 3	-	125	865	315 $_{-1.0}^{0}$	203	254

() : 2 pole Motor

Construction around drive shaft

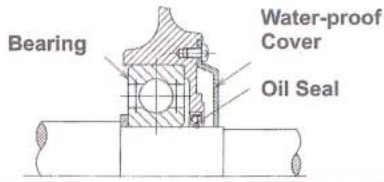

Construction for Terminal Box

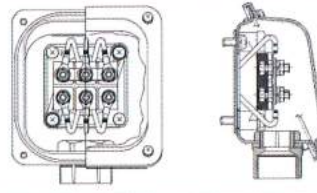

Shaft Dimension

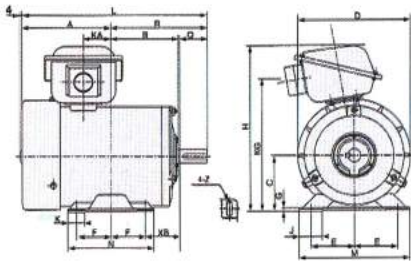
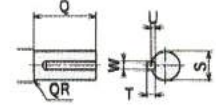

Fig.1

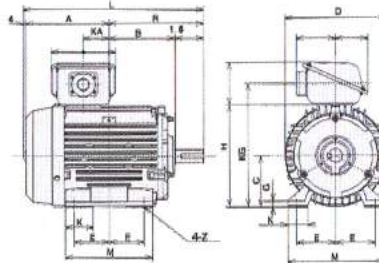

Fig.2

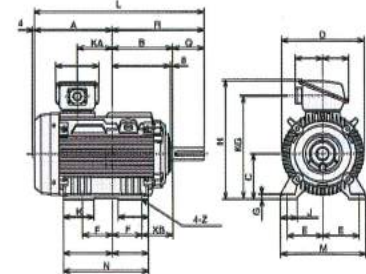

Fig.3

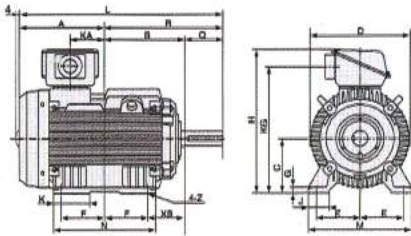

Fig.4

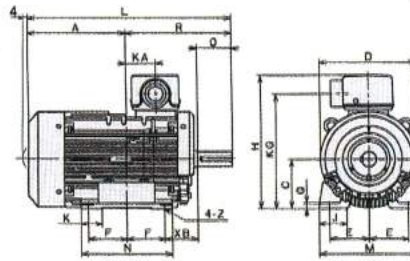

Fig.5

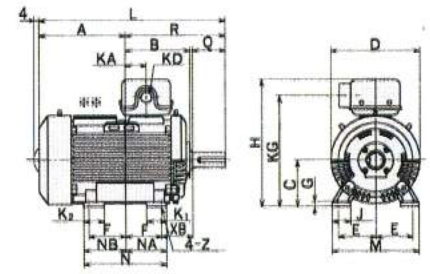

Fig.6

Dimension in mm											Approx Weight (kg)			Approx Packing Dimension (cm)
N	M	G	Z	XB	S	W	U	T	Q	QR	2 Pole	4 Pole	6 Pole	H x W x L
115	140	3.2	7x20	45	14 ^{+0.008} / _{-0.003}	5	3	5	30	1	9.5	8.2	-	29 x 19 x 30
125	160	3.2	10x25	50	19 ^{+0.009} / _{-0.004}	6	3.5	6	40	0.3	13.5	12.5	16	30 x 20 x 34
155	170	10	10	56	24 ^{+0.009} / _{-0.004}	8	4	7	50	0.3	15 16	16	16	32 x 23 x 39
175	195	12.5	12	63	28 ^{+0.009} / _{-0.004}	8	4	7	60	0.5	-	21	23	36 x 30 x 40
175	224	14	12	70	28 ^{+0.009} / _{-0.004}	8	4	7	60	0.5	27.5	28	30	36 x 32 x 41
175	250	16	12	89	38 ^{+0.018} / _{+0.002}	10	5	8	80	0.5	39 44	40	41	42 x 35 x 52
212	250	16	12	89	38 ^{+0.018} / _{+0.002}	10	5	8	80	0.5	-	48	52	42 x 35 x 56
300	300	18	14.5	108	42 ^{+0.018} / _{+0.002}	12	5	8	110	1	70 79	73	75	50 x 51 x 66
300	300	18	14.5	108	42 ^{+0.018} / _{+0.002}	12	5	8	110	1	85	85	90	50 x 51 x 66
300	350	20	14.5	118	48 ^{+0.018} / _{+0.002}	14	5.5	9	110	1.5	115	120 130	130	61 x 45 x 73
335	350	20	14.5	118	55 ^{+0.030} / _{+0.011}	16	6	10	110	1.5	145	160	155 165	64 x 45 x 86
365	400	23	18.5	133	(55 ^{+0.030} / _{+0.011}) (60 ^{+0.030} / _{+0.011})	(16) 18	(6) 7	(10) 11	(110) 140	(-) 1.5	205 215	215 235	225 245	67 x 50 x 94
350	450	23	18.5	149	(55 ^{+0.030} / _{+0.011}) (65 ^{+0.030} / _{+0.011})	(16) 18	(6) 7	(10) 11	(110) 140	(-) 2.5	240	265	270	72 x 56 x 96
420	500	30	24	168	(55 ^{+0.030} / _{+0.011}) (75 ^{+0.030} / _{+0.011})	(16) 20	(6) 7.5	(10) 12	(110) 140	-	470	490	475	85 x 62 x 112
420	500	30	24	168	(55 ^{+0.030} / _{+0.011}) (75 ^{+0.030} / _{+0.011})	(16) 20	(6) 7.5	(10) 12	(110) 140	-	490	535	555	85 x 62 x 112
490	550	30	24	190	(55 ^{+0.030} / _{+0.011}) (85 ^{+0.030} / _{+0.011})	(16) 22	(6) 9	(10) 14	(110) 170	-	630	645	685	92 x 67 x 122
490	550	30	24	190	(55 ^{+0.030} / _{+0.011}) (85 ^{+0.030} / _{+0.011})	(16) 22	(6) 9	(10) 14	(110) 170	-	675	725	745	92 x 67 x 122
540	615	28	28	216	95 ^{+0.035} / _{+0.013}	25	9	14	170	-	-	-	930	97 x 73 x 134

Three-Phase Induction Motors

Totally Enclosed Fan-Cooled Type (TEFC)

IP44 Series / Flange Type (Vertical Type) [VTFO-K(KK)]

1/7~180HP (0.1~132kW)



Model:

xxHP or kW VTFO-K(KK) xP IP44

Output

No of pole

Item		Specifications	
Motor Output		1/7~180HP (0.1~132kW)	
Rating		Continuous [S1]	
Number of pole		2, 4, 6 pole [8 Pole : only some range]	
Insulation Class		B Type	~180 M
		F Type	180 L~
Enclosure		IP44 (Outdoor type is also available)	
Voltage, Frequency		Consult to nearest representative	
Number of Cable		~5 HP 6 Wires (Direct starting 220V or 380V)	
		7.5 HP ~ 6 Wires (Star Δ - Δ Delta Starting)	
		2 pole 30 HP ~	12 Wires (Star Δ - Δ Delta Starting)
		4 pole 40 HP ~	
6 pole 50 HP ~			
Color		Alcron gray	
Rotation		CCW (View from motor drive end)	
Environment	Temperature	-30 ~ 40 °C	
	Humidity	Enclosed type Max 95% RH	
	Altitude	Max 1,000 m	

Type From	Flange size	Frame size	Output (HP)			Insulation	Fig. No	Dimension in mm							
			2 Pole	4 Pole	6 Pole			LA	LB	LC	LE	LG	LZ	D	
VTO-K	FF130	63M	-	1/7 1/4	-	B	1	130	110	+0.013 -0.009	160	3.5	8	10	116
VTFO-K	FF130	71M	1/2	1/2	-	B	2	130	110	+0.013 -0.009	160	3.5	10	10	145
	FF165	80M	1	1	1/2	B	2	165	130	+0.014 -0.011	200	3.5	12	12	163
		90L	2 3	2	1	B	3	165	130	+0.014 -0.011	200	3.5	12	12	180
	FF215	100L	-	3	2	B	4	215	180	+0.014 -0.011	250	4	16	14.5	199
		112M	5	5	3	B	4	215	180	+0.014 -0.011	250	4	16	14.5	223
VTFO-KK	FF265	132S	7.5 10	7.5	5	B	5	265	230	+0.016 -0.013	300	4	20	14.5	250
		132M	-	10	7.5	B	5	265	230	+0.016 -0.013	300	4	20	14.5	250
	FF300	160M	15 20	15	10	B	5	300	250	+0.016 -0.013	350	5	20	18.5	290
		160L	25	20	15	B	5	300	250	+0.016 -0.013	350	5	20	18.5	290
	FF350	180M	30	25 30	20	B	5	350	300	+0.016 -0.016	395	5	20	18.5	340
VTFO-KK	FF350	180L	40	40	25 30	F	5	350	300	+0.016 -0.016	395	5	20	18.5	340
	FF400	(200LB) 200L	50 60	50 60	40 50	F	6	400	350	+0.018 -0.018	445	5	22	18.5	391
		(225SB) 225S	75	75	60	F	6	500	450	+0.020 -0.020	545	5	22	18.5	391
	FF500	(250MD) 250M	100 120	100 120	75 100	F	7	500	450	+0.020 -0.020	545	5	22	18.5	490
		(280MD) 280M	150 180	150 180	120 150	F	7	600	550	+0.022 -0.022	655	6	25	24	550
	FF600	(315M)	-	-	180	F	7	600	550	+0.022 -0.022	655	6	25	24	633

() : 2 pole Motor

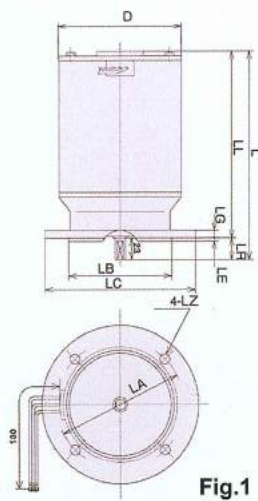

Fig.1

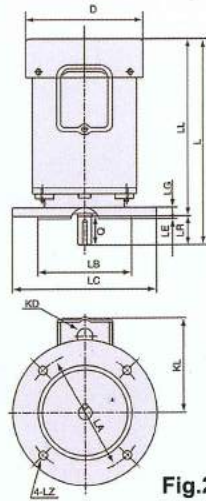

Fig.2

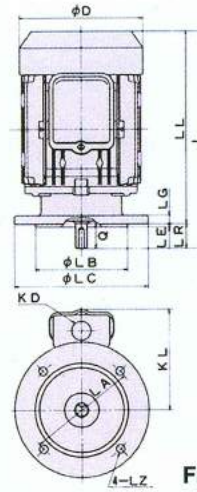

Fig.3

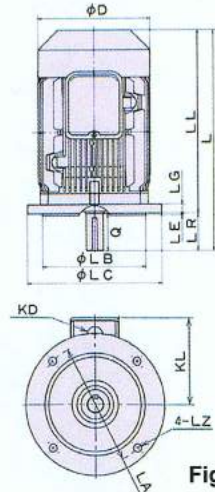

Fig.4

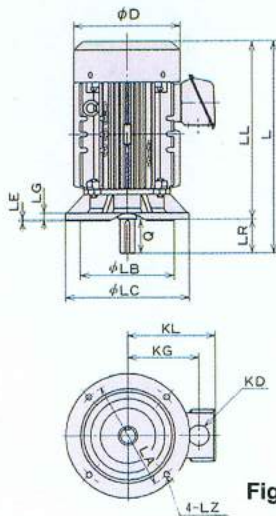

Fig.5

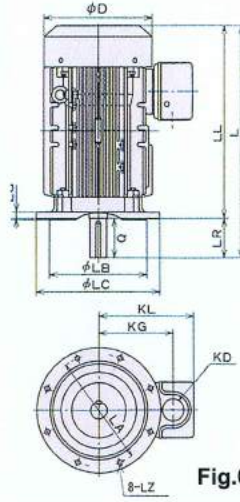

Fig.6

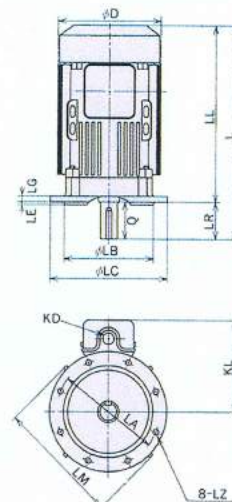
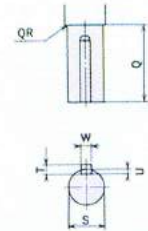

Fig.7



Shaft Dimension

Dimension in mm											Bearing No.		Approx Weight (kg)			Approx Packing Dimension (cm)
L	LL	KL	KD	LR	S	W	U	T	Q	QR	Drive End Side	Opposite Side	2 Pole	4 Pole	6 Pole	H x W x L
219	196	-	-	23	11 ⁺⁰ _{-0.011}	-	1	-	23	-	6202ZZ	6202ZZ	6.9	-	-	23 x 21.5 x 31.5
256	226	123	22	30	14 ^{+0.008} _{-0.003}	5	3	5	30	1	6203ZZ	6203ZZ	10.5	9	-	32 x 25 x 28
283	243	131	22	40	19 ^{+0.009} _{-0.004}	6	3.5	6	40	0.3	6204ZZ	6204ZZ	15.5	14.4	17.5	34 x 30 x 32
324	274	145	22	50	24 ^{+0.009} _{-0.004}	8	4	7	50	0.3	6205ZZ	6205ZZ	17	18	17	40 x 30 x 33
356	296	153	28	60	28 ^{+0.009} _{-0.004}	8	4	7	60	0.5	6206ZZ	6206ZZ	-	24	25	41 x 35 x 37
372	312	166.5	28	60	28 ^{+0.009} _{-0.004}	8	4	7	60	0.5	6306ZZ	6306ZZ	30	32	32	47 x 35 x 37
427.5	347.5	197	36	80	38 ^{+0.018} _{+0.002}	10	5	8	80	0.5	6308ZZ	6306ZZ	43	44	45	55 x 41 x 43
465.5	385.5	197	36	80	38 ^{+0.018} _{+0.002}	10	5	8	80	0.5	6308ZZ	6306ZZ	-	52	57	59 x 41 x 43
595	485	256	52	110	42 ^{+0.018} _{+0.002}	12	5	8	110	1.0	6309ZZ	6307ZZ	83	85	82	70 x 42 x 52
595	485	256	52	110	42 ^{+0.018} _{+0.002}	12	5	8	110	1.0	6309ZZ	6307ZZ	90	90	96	70 x 42 x 52
670	560	279	52	110	48 ^{+0.018} _{+0.002}	14	5.5	9	110	1.0	6312ZZ	6309ZZ	130	130	140	80 x 50 x 56
743	633	314	52	110	55 ^{+0.030} _{+0.011}	16	6	10	110	1.5	6312ZZ	6309ZZ	140	165	160	87 x 50 x 59
(790)	680	341.5	52	(110)	(55 ^{+0.030} _{+0.011})	(16)	(6)	(10)	(110)	(-)	(6312)	(6312ZZ)	210	220	230	(90 x 53 x 64)
820				140	60	18	7	11	140	1.5	6313ZZ	6312ZZ	220	240	250	93 x 53 x 64
(826.5)	716.5	341.5	78	(110)	(55 ^{+0.030} _{+0.011})	(16)	(6)	(10)	(110)	(-)	(6312)	(6312ZZ)	245	270	275	(93 x 65 x 68)
856.5				140	65	18	7	11	140	2.5	6315ZZ	6312ZZ	245	270	275	96 x 65 x 68
(909)	799	485	78	(110)	(55 ^{+0.030} _{+0.011})	(16)	(6)	(10)	(110)	-	(6313C3)	(6313C3)	470	490	490	(103 x 71 x 91)
939				140	75	20	7.5	12	140	-	6316	6313ZZ	490	540	550	106 x 71 x 91
(1012)	(902)	515	92	(110)	(55 ^{+0.030} _{+0.011})	(16)	(6)	(10)	(110)	-	(6313C3)	(6313C3)	660	675	680	(113 x 81 x 100)
1068				170	85	22	9	14	170	-	6318	6315ZZ	680	730	750	119 x 81 x 100
1228	1058	550	92	170	95 ^{+0.035} _{+0.013}	25	9	14	170	-	6320	6318	-	-	980	135 x 96 x 110

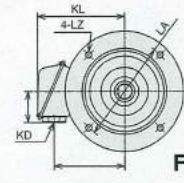
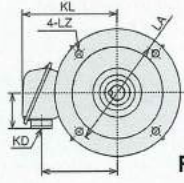
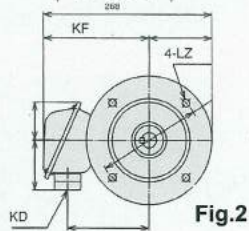
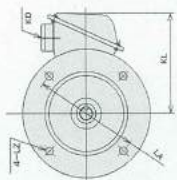
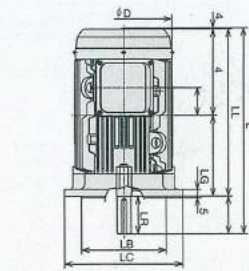
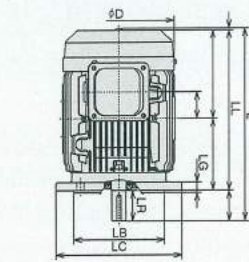
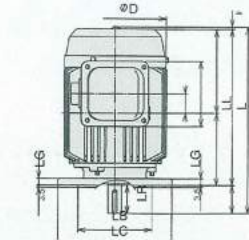
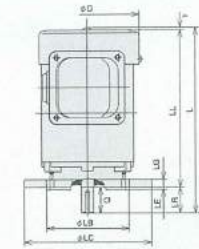

Fig.1

Fig.2

Fig.3

Fig.4

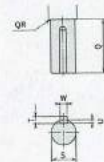
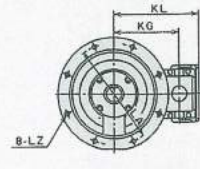
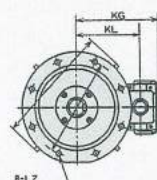
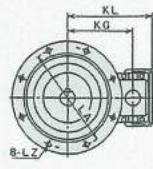
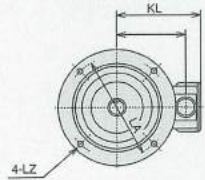
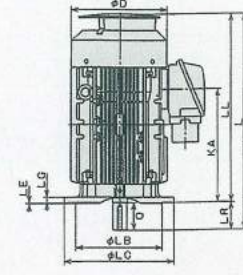
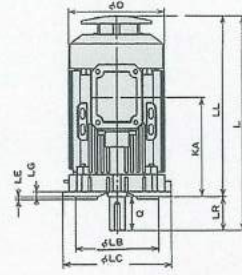
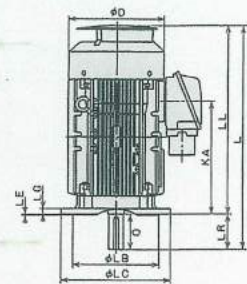
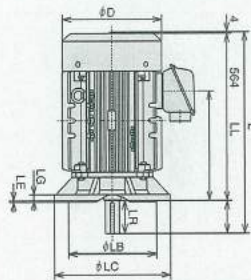

Fig.5

Fig.6

Fig.7

Fig.8

Shaft Dimension

Dimension in mm										Approx Weight (kg)			Approx Packing Dimension (cm)
LL	KD	KL	LR	S	W	U	T	Q	QR	2 Pole	4 Pole	6 Pole	H x W x L
230	PF 3/4	148	30	14 <small>+0.008 -0.003</small>	5	3	5	30	1	10.5	9	-	32 x 25 x 28
247	PF 3/4	156	40	19 <small>+0.009 -0.004</small>	6	3.5	6	40	0.3	15.5	14.4	17.5	34 x 30 x 32
277	PF 3/4	168	50	24 <small>+0.009 -0.004</small>	8	4	7	50	0.3	17 18	18	17	40 x 30 x 33
300	PF 1	176	60	28 <small>+0.009 -0.004</small>	8	4	7	60	0.5	-	24	25	41 x 35 x 37
316	PF 1	166.5	60	28 <small>+0.009 -0.004</small>	8	4	7	60	0.5	30	32	32	47 x 35 x 37
351.5	PF 1 1/4	197	80	38 <small>+0.018 +0.002</small>	10	5	8	80	0.5	43 48	44	45	55 x 41 x 43
389.5	PF 1 1/4	197	80	38 <small>+0.018 +0.002</small>	10	5	8	80	0.5	-	52	57	59 x 41 x 43
489	PF 1 1/2	259.5	110	42 <small>+0.018 +0.002</small>	12	5	8	110	1.0	83 89	85	82	70 x 42 x 52
489	PF 1 1/2	259.5	110	42 <small>+0.018 +0.002</small>	12	5	8	110	1.0	90	90	96	70 x 42 x 52
564	PF 2	282.5	110	48 <small>+0.018 +0.002</small>	14	5.5	9	110	1.0	130	130 140	140	80 x 50 x 56
637	PF 2 1/2	317.5	110	55 <small>+0.030 +0.011</small>	16	6	10	110	1.5	140	165	160 170	87 x 50 x 59
680	PF 2 1/2	341.5	(110) 140	(55) 60 <small>+0.030 +0.011 +0.030 +0.011</small>	(16) 18	(6) 7	(10) 11	(110) 140	(-) 1.5	210 220	220 240	230 250	(90 x 53 x 64) 93 x 53 x 64
716.5	PF 2 1/2	341.5	(110) 140	(55) 65 <small>+0.030 +0.011 +0.030 +0.011</small>	(16) 18	(6) 7	(10) 11	(110) 140	(-) 2.5	245	270	275	(93 x 65 x 68) 96 x 65 x 68
799	PF 2 1/2	485	(110) 140	(55) 75 <small>+0.030 +0.011 +0.030 +0.011</small>	(16) 20	(6) 7.5	(10) 12	(110) 140	-	470 490	490 540	490 550	(103 x 71 x 91) 106 x 71 x 91
(902) 898	PF 3	515	(110) 170	(55) 85 <small>+0.030 +0.011 +0.030 +0.011</small>	(16) 22	(6) 9	(10) 14	(110) 170	-	660 680	675 730	680 750	(113 x 81 x 100) 119 x 81 x 100
1058	PF 3	550	170	95 <small>+0.035 +0.013</small>	25	9	14	170	-	-	-	980	135 x 96 x 110

Characteristics and Performance of Three Phase Motor

1. The figures are reference data. If you need guaranteed performance data, please contact (Sales agent)
2. Only torque (full-load, starting, maximum, accelerating) and starting current are actual measurement value. Other data are equivalent circuit measures.
3. Not only current but also other characteristics may be changed under different voltage specifications. Please contact (Sales agent), if required any clarification.

2 pole 50Hz

Rated Output HP kW	Volt	Hz	Rated Speed (min ⁻¹)	Torque			Current				Efficiency			Power Factor			Moment of Inertia J (kg - m ²)
				Rated (Nm)	Start (%)	Max (%)	50% (A)	75% (A)	100% (A)	Start (A)	50% (%)	75% (%)	100% (%)	50% (%)	75% (%)	100% (%)	
1/2 0.4	220	50	2910	1.34	265	295	1.3	1.5	1.8	11.0	68.0	72.5	73.5	61.5	74.5	83.5	0.000675
	380		2910	1.34	265	295	0.73	0.84	1.0	6.5	68.0	72.5	73.5	61.5	74.5	83.5	
	415		2920	1.33	320	350	0.82	0.90	1.0	7.0	63.0	69.0	71.5	54.0	67.0	76.5	
1 0.75	220	50	2900	2.51	210	275	1.9	2.4	3.0	19.0	76.0	78.0	77.5	67.0	79.5	86.0	0.000973
	380		2900	2.51	210	275	1.1	1.4	1.7	11.0	76.0	78.0	77.5	67.0	79.5	86.0	
	415		2900	2.49	255	335	1.3	1.5	1.7	12.0	71.5	76.0	77.0	58.0	71.0	79.5	
2 1.5	220	50	2900	5.03	220	260	3.3	4.3	5.4	33.0	80.5	81.5	80.5	73.5	84.0	89.5	0.00170
	380		2900	5.03	220	260	1.9	2.5	3.1	19.0	80.5	81.5	80.5	73.5	84.0	89.5	
	415		2900	5.05	265	310	2.1	2.5	3.0	21.0	78.0	81.0	81.0	64.0	76.5	84.0	
3 2.2	220	50	2860	7.41	300	290	5.0	6.3	8.0	61.0	83.5	84.0	83.0	70.0	82.0	87.5	0.00190
	380		2860	7.41	300	290	2.9	3.6	4.6	35.0	83.5	84.0	83.0	70.0	82.0	87.5	
	415		2870	7.34	370	355	3.5	4.0	4.8	39.0	79.5	82.0	82.0	55.5	69.5	78.0	
5 3.7	220	50	2860	12.4	270	300	7.1	9.7	12.5	90.0	84.0	85.0	84.5	81.5	88.5	91.5	0.00520
	380		2860	12.4	270	300	4.1	5.6	7.2	52.0	84.0	85.0	84.5	81.5	88.5	91.5	
	415		2890	12.7	335	375	4.5	5.7	6.9	58.0	82.0	84.0	84.5	69.5	80.0	86.0	
7.5 5.5	380	50	2890	17.9	250	300	5.9	8.1	10.7	76.0	87.5	88.5	88.5	81.0	87.0	89.5	0.00920
	415		2900	17.8	310	380	6.4	8.1	10.7	85.0	86.0	88.0	88.5	70.0	80.0	85.0	
10 7.5	380	50	2900	24.3	240	275	7.7	10.7	14.0	105.0	88.5	90.0	89.5	83.5	89.0	90.5	0.0111
	415		2910	24.2	300	345	8.2	10.7	13.7	120.0	87.5	89.5	89.5	73.0	82.0	86.5	
15 11	380	50	2900	35.7	260	295	11.7	16.0	21	150.0	88.5	90.0	90.0	80.5	87.0	89.5	0.0193
	415		2910	35.6	320	365	13.2	16.6	21	165.0	87.0	89.0	89.5	66.5	77.5	83.0	
20 15	380	50	2900	49.0	300	325	15.8	21.6	28	210.0	90.5	91.0	90.5	80.0	87.0	89.5	0.0234
	415		2910	48.8	375	410	17.9	22.5	28	235.0	89.0	90.5	90.5	65.5	77.0	82.5	
25 18.5	380	50	2910	59.9	300	320	19.0	26.2	34	260.0	90.5	91.5	91.5	81.5	88.0	90.5	0.0264
	415		2930	59.8	375	395	21.5	27.2	34	290.0	89.0	91.0	91.0	67.0	78.0	83.5	
30 22	380	50	2920	71.0	280	330	23.5	31.8	41	320.0	89.5	91.0	91.0	79.5	86.5	89.5	0.0537
	415		2920	70.8	340	405	26.6	33.1	41	350.0	87.0	89.5	90.5	66.0	77.0	83.0	
40 30	380	50	2920	97.6	245	280	30.0	42.0	55	385.0	89.0	90.0	89.5	85.5	90.5	92.0	0.0613
	415		2930	97.3	290	335	33.2	42.9	54	420.0	87.5	89.5	89.5	72.0	81.5	86.0	
50 37	380	50	2930	120	230	230	37.3	52.4	69	445.0	88.5	90.0	90.5	85.0	89.0	90.0	0.111
	415		2940	120	230	280	40.7	53.1	67	490.0	87.5	90.0	90.5	72.0	81.0	84.5	
60 45	380	50	2920	146	250	245	45.3	63.5	84	575.0	88.5	90.0	90.5	85.0	89.5	90.5	0.120
	415		2930	146	305	300	49.1	64.0	81	635.0	88.0	90.0	90.5	72.5	81.5	85.5	
75 55	380	50	2920	178	275	270	53.8	76.0	100	730.0	90.5	92.0	91.5	85.5	90.0	91.0	0.140
	415		2940	178	340	340	58.6	76.8	98	805.0	90.0	91.5	91.5	72.5	81.5	85.5	

4 pole**50Hz**

Rated Output		Volt	Hz	Rated Speed (min ⁻¹)	Torque			Current				Efficiency			Power Factor			Moment of Inertia J (kg - m ²)
HP	kW				Rated	Start	Max	50%	75%	100%	Start	50%	75%	100%	50%	75%	100%	
					(Nm)	(%)	(%)	(A)	(A)	(A)	(A)	(%)	(%)	(%)	(%)	(%)	(%)	
1/2	0.4	220	50	1410	2.77	245	260	1.4	1.6	1.9	8.0	70.0	73.0	72.5	55.5	69.5	79.0	0.000973
		380		1410	2.77	245	260	0.78	0.90	1.1	4.5	70.0	73.0	72.5	55.5	69.5	79.0	
		415		1425	2.72	300	320	0.88	1.0	1.1	5.0	65.5	70.5	72.0	48.0	61.0	71.0	
1	0.75	220	50	1410	5.10	220	265	1.9	2.4	3.0	15.0	79.0	80.0	78.0	64.5	76.5	83.0	0.000213
		380		1410	5.10	220	265	1.1	1.4	1.7	8.5	79.0	80.0	78.0	64.5	76.5	83.0	
		415		1425	5.03	270	330	1.2	1.4	1.7	9.5	76.5	79.0	78.5	57.0	70.0	78.0	
2	1.5	220	50	1420	10.3	225	250	4.0	4.9	6.1	31.0	79.5	80.5	78.0	61.5	74.5	82.0	0.00330
		380		1420	10.3	225	250	2.3	2.9	3.5	18.0	79.5	80.5	78.0	61.5	74.5	82.0	
		415		1435	10.2	275	305	2.6	3.0	3.5	20.0	76.5	79.0	78.5	51.5	65.5	74.5	
3	2.2	220	50	1430	15.1	230	250	5.5	6.9	8.5	48.0	82.5	82.5	80.5	64.0	76.5	83.0	0.00570
		380		1430	15.1	230	250	3.2	4.0	4.9	28.0	82.5	82.5	80.5	64.0	76.5	83.0	
		415		1440	14.9	280	310	3.6	4.2	4.8	31.0	80.0	82.0	81.0	54.0	67.5	76.0	
5	3.7	220	50	1410	25.4	220	240	8.4	10.8	13.9	80.0	84.5	84.0	81.5	69.0	80.0	85.5	0.0110
		380		1410	25.4	220	240	4.8	6.3	8.0	46.0	84.5	84.0	81.5	69.0	80.0	85.5	
		415		1430	25.1	270	300	5.5	6.6	8.0	52.0	81.5	83.0	82.0	57.0	70.5	78.5	
7.5	5.5	380	50	1435	36.1	240	290	6.7	8.8	11.5	67.0	87.5	88.0	87.0	70.5	81.0	86.0	0.0171
		415		1440	35.9	285	345	7.5	9.1	11.5	73.0	85.5	87.0	87.0	59.5	72.5	80.0	
10	7.5	380	50	1430	49.1	275	295	9.0	11.8	15.5	98.0	88.5	89.0	88.0	71.5	82.0	86.5	0.0214
		415		1440	48.9	335	365	9.9	12.1	15.5	105.0	86.5	88.0	88.0	61.0	73.5	80.5	
15	11	380	50	1440	71.8	240	265	12.9	17.1	22	135.0	88.5	89.0	88.0	73.0	82.0	86.0	0.0345
		415		1450	71.5	285	315	14.6	17.9	22	145.0	86.0	88.0	88.0	61.0	73.0	79.5	
20	15	380	50	1450	98.3	260	295	17.2	22.8	29	195.0	90.5	90.5	89.5	73.5	82.5	86.5	0.0446
		415		1450	97.8	315	355	19.3	23.7	29	215.0	88.0	89.5	89.0	61.5	74.0	80.5	
25	18.5	380	50	1455	121	245	265	21.5	28.4	37	240.0	89.0	90.0	89.5	73.5	82.5	86.5	0.0876
		415		1455	120	295	320	25.0	30.3	37	265.0	86.5	88.5	89.0	59.5	72.0	78.5	
30	22	380	50	1455	143	275	300	24.9	33.2	43	305.0	90.0	91.0	90.5	74.5	83.0	86.5	0.101
		415		1460	142	335	370	27.9	34.5	43	340.0	88.0	90.0	90.5	62.0	74.0	80.0	
40	30	380	50	1460	196	275	310	33.1	44.5	58	420.0	90.5	91.0	90.5	76.0	84.5	87.5	0.127
		415		1460	195	340	385	36.9	46.0	57	465.0	89.5	90.5	90.5	63.5	75.0	81.0	
50	37	380	50	1450	240	245	270	40.8	55.0	72	470.0	90.5	91.5	91.0	76.0	84.0	86.5	0.208
		415		1460	239	300	335	44.6	56.1	70	520.0	89.5	91.0	91.0	64.5	75.5	81.0	
60	45	380	50	1450	292	235	265	48.5	66.0	86	570.0	91.0	92.0	91.5	77.0	84.5	87.0	0.230
		415		1465	292	285	330	53.0	67.1	84	630.0	90.0	91.5	91.5	65.5	76.5	81.5	
75	55	380	50	1455	356	280	275	60.2	81.1	105	735.0	92.0	93.0	92.5	75.0	83.5	86.5	0.280
		415		1460	355	340	340	70.1	86.3	107	810.0	90.5	92.0	92.0	60.0	72.0	78.5	
100	75	380	50	1470	486	295	300	72.7	102.3	135	1124	92.0	93.0	93.0	85.5	90.0	91.5	1.00
		415		1475	484	365	375	72.6	97.9	130	1248	91.5	92.5	93.0	78.5	86.0	89.0	
120	90	380	50	1470	579	355	405	86.3	121.3	160	1547	93.5	94.5	94.5	85.0	89.5	91.0	1.25
		415		1475	578	440	505	86.3	116.3	150	1720	92.5	94.0	94.0	78.0	86.0	89.0	
150	110	380	50	1475	712	345	305	105.2	148.8	200	1548	93.0	94.0	93.5	85.0	89.5	91.0	1.98
		415		1480	710	430	380	104.4	141.9	185	1710	92.5	93.5	94.0	79.0	86.0	89.0	
175	132	380	50	1475	855	385	345	125.9	177.6	240	2002	93.5	94.0	94.0	85.0	90.0	91.5	2.30
		415		1480	852	480	410	123.8	168.4	220	2213	93.5	94.0	94.5	79.5	86.5	89.5	

6 pole

50Hz

Rated Output		Volt	Hz	Rated Speed (min ⁻¹)	Torque			Current				Efficiency			Power Factor			Moment of Inertia J (kg - m ²)
HP	kW				Rated	Start	Max	50%	75%	100%	Start	50%	75%	100%	50%	75%	100%	
					(Nm)	(%)	(%)	(A)	(A)	(A)	(A)	(%)	(%)	(%)	(%)	(%)	(%)	
1/2	0.4	220	50	940	4.13	225	270	1.6	1.8	2.1	9.0	66.5	70.5	70.5	49.0	62.5	72.5	0.00215
		380		940	4.13	225	270	0.93	1.0	1.2	5.0	66.5	70.5	70.5	49.0	62.5	72.5	
		415		950	4.06	280	330	1.0	1.1	1.2	5.5	63.5	69.0	70.5	43.5	56.0	66.0	
1	0.75	220	50	930	7.97	220	240	2.9	3.2	3.8	15.0	68.5	71.0	69.5	50.5	64.0	73.5	0.00460
		380		930	7.97	220	240	1.7	1.9	2.2	8.5	68.5	71.0	69.5	50.5	64.0	73.5	
		415		940	7.97	260	285	1.9	2.0	2.3	9.5	64.0	69.0	69.5	43.5	56.0	66.0	
2	1.5	220	50	930	15.4	210	240	4.6	5.5	6.6	32.0	76.5	77.5	74.5	56.0	69.5	77.0	0.00870
		380		930	15.4	210	240	2.7	3.2	3.8	18.0	76.5	77.5	74.5	56.0	69.5	77.0	
		415		930	15.4	250	285	3.0	3.4	3.9	19.0	71.5	74.5	73.5	49.0	62.5	71.5	
3	2.2	220	50	940	22.5	260	270	6.2	7.4	9.4	52.0	80.0	81.5	80.0	58.5	72.0	79.5	0.0132
		380		940	22.5	260	270	3.6	4.3	5.4	30.0	80.0	81.5	80.0	58.5	72.0	79.5	
		415		950	22.2	325	340	4.0	4.5	5.4	33.0	77.0	80.0	80.0	50.0	63.5	72.5	
5	3.7	220	5	930	38.2	210	255	8.9	11.4	14.5	80.0	85.0	84.5	82.0	64.5	76.0	81.0	0.0256
		380		930	38.2	210	255	5.1	6.6	8.4	46.0	85.0	84.5	82.0	64.5	76.0	81.0	
		415		940	38.5	265	320	5.6	6.7	8.2	52.0	83.0	84.0	83.0	55.0	68.0	75.5	
7.5	5.5	380	50	940	54.9	265	285	7.6	9.7	12.7	71.0	88.0	88.0	86.5	62.5	73.5	78.5	0.0343
		415		950	54.5	315	340	8.6	10.2	12.6	77.0	85.0	87.0	86.5	52.5	65.0	72.0	
10	7.5	380	50	960	73.2	245	340	10.3	12.8	16.5	115.0	87.0	88.0	87.0	63.5	76.0	82.5	0.0551
		415		960	72.9	305	425	12.1	14.0	17.0	125.0	83.0	85.5	86.0	51.5	65.5	74.0	
15	11	380	50	960	108	250	345	13.7	17.6	23	160.0	89.0	89.0	88.0	68.5	80.0	85.0	0.0727
		415		960	107	310	430	15.3	18.4	23	175.0	86.5	88.0	88.0	57.5	71.0	78.5	
20	15	380	50	965	146	235	265	18.3	23.9	31	190.0	90.5	90.5	90.0	69.0	79.0	83.0	0.140
		415		965	145	285	315	20.8	25.1	31	205.0	87.0	89.0	89.0	57.5	70.0	76.5	
25	18.5	380	50	965	181	240	265	22.1	29.0	38	220.0	89.5	90.0	89.5	71.0	80.5	84.5	0.164
		415		965	180	295	325	24.6	30.1	37	245.0	87.0	89.0	89.0	60.0	72.0	78.5	
30	22	380	50	965	214	265	295	26.4	34.5	45	280.0	90.0	90.5	90.0	70.5	80.0	84.5	0.190
		415		965	213	325	370	29.9	36.2	44	310.0	87.5	89.5	89.5	58.5	71.0	77.5	
40	30	380	50	965	291	225	280	36.2	47.1	61	380.0	90.5	91.5	91.0	69.5	79.5	84.0	0.333
		415		970	291	275	345	41.3	49.7	61	420.0	88.5	90.5	90.5	57.0	69.5	76.5	
50	37	380	50	970	360	230	275	43.8	57.5	74	455.0	91.5	92.0	91.5	70.0	80.0	84.0	0.382
		415		970	359	285	340	49.0	59.7	74	505.0	90.0	91.0	91.0	58.5	71.0	77.5	
60	45	380	50	970	438	250	275	50.8	67.8	88	535.0	92.0	92.0	91.0	73.5	82.5	86.0	0.430
		415		975	437	300	330	57.8	71.1	88	590.0	90.0	91.0	91.0	60.0	72.5	79.0	
75	55	380	50	975	533	255	265	58.7	80.1	105	695.0	93.0	93.0	92.5	76.5	84.0	86.5	0.880
		415		975	532	310	325	62.4	79.9	105	770.0	92.0	93.0	92.5	66.5	77.0	82.0	

2 pole

60Hz

Rated Output		Poles	Volt	Hz	Rated Speed (min-1)	Torque			Current				Efficiency			Power Factor		
HP	kW					Rated (Nm)	Start (%)	Max (%)	50% (A)	75% (A)	100% (A)	Start (A)	50% (%)	75% (%)	100% (%)	50% (%)	75% (%)	100% (%)
1/2	0.4	2	220	60	3480	1.10	245	320	1.1	1.3	1.6	10.0	71.5	75.0	75.0	69.5	81.5	88.0
			380		3480	1.10	245	320	0.61	0.75	0.90	5.8	71.5	75.0	75.0	69.5	81.5	88.0
			440		3500	1.09	330	380	0.67	0.76	0.88	6.8	67.0	73.0	75.0	58.0	71.0	79.5
1	0.75	2	220	60	3470	2.07	190	245	1.7	2.3	2.8	16.5	77.0	79.0	78.0	77.0	86.0	90.0
			380		3470	2.07	190	245	0.96	1.3	1.6	9.5	77.0	79.0	78.0	77.0	86.0	90.0
			440		3490	2.05	265	340	1.0	1.2	1.5	11.5	74.5	78.5	79.0	65.0	77.0	84.0
2	1.5	2	220	60	3470	4.13	200	240	2.9	4.0	5.4	31	80.0	81.5	80.0	83.0	90.0	93.0
			380		3470	4.13	200	240	1.7	2.3	3.1	18.0	80.0	81.5	80.0	83.0	90.0	93.0
			440		3490	4.11	275	325	1.8	2.2	2.7	21	79.0	81.5	82.0	71.5	82.0	87.5
3	2.2	2	220	60	3430	6.13	260	240	4.2	5.7	7.6	54	84.0	84.5	83.0	82.5	90.0	92.5
			380		3430	6.13	260	240	2.4	3.3	4.4	31	84.0	84.5	83.0	82.5	90.0	92.5
			440		3460	6.08	365	340	2.5	3.2	3.9	37	83.0	85.0	84.5	69.5	81.0	86.5
5	3.7	2	220	60	3420	10.3	220	260	6.4	9.2	12.3	83	83.5	84.5	83.5	90.5	93.5	94.0
			380		3420	10.3	220	260	3.7	5.3	7.1	48	83.5	84.5	83.5	90.5	93.5	94.0
			440		3460	10.2	315	355	3.6	4.8	6.2	57	83.0	85.5	85.5	82.5	89.0	91.5
7.5	5.5	2	380	60	3480	15.1	185	240	5.6	7.9	10.5	65	85.0	87.0	87.0	87.5	90.5	91.0
			440		3510	15.0	265	340	5.3	7.1	9.2	77	85.0	87.5	88.5	80.0	86.5	89.5
10	7.5	2	380	60	3480	20.6	200	235	7.4	10.6	14.0	90	86.5	88.5	88.5	88.5	91.5	91.5
			440		3510	20.4	290	335	6.9	9.4	12.1	107	86.5	88.5	89.5	82.5	88.5	90.5
15	11	2	380	60	3490	30.1	225	245	10.7	15.2	20.0	128	87.5	89.0	89.0	90.0	92.5	92.5
			440		3520	29.9	320	350	10.4	14.0	17.9	152	86.0	89.0	89.5	80.5	87.5	90.0
20	15	2	380	60	3490	41.1	260	275	14.2	20.4	27.3	178	89.0	90.5	90.0	90.0	92.5	93.0
			440		3520	40.7	370	390	13.8	18.7	24.1	212	88.0	90.0	90.5	81.0	87.5	90.0
25	18.5	2	380	60	3490	50.6	255	255	17.2	24.8	33.1	224	90.0	91.0	91.0	91.0	93.5	93.5
			440		3520	50.2	365	365	16.6	22.7	29.2	266	89.0	91.0	91.5	82.0	88.5	91.0

4 pole

60Hz

Rated		Poles	Volt	Hz	Rated	Torque			Current				Efficiency			Power Factor			Moment of Inertia J
Output	Speed				Rated	Start	Max	50%	75%	100%	Start	50%	75%	100%	50%	75%	100%		
HP kW	(min ⁻¹)				(Nm)	(%)	(%)	(A)	(A)	(A)	(A)	(%)	(%)	(%)	(%)	(%)	(%)	(kg . m ²)	
1/2	0.4	4	220	60	1690	2.26	225	255	1.1	1.4	1.7	7.3	75.0	76.5	75.0	62.5	75.5	83.5	0.000973
			380	1690	2.26	225	255	0.65	0.79	0.98	4.2	75.0	76.5	75.0	62.5	75.5	83.5		
			440	1710	2.24	310	355	0.74	0.83	0.98	4.9	70.5	75.0	76.0	50.0	63.5	73.0		
1	0.75	4	220	60	1700	4.22	195	260	1.7	2.3	2.9	13.7	81.0	81.0	78.0	70.5	81.0	85.5	0.002130
			380	1700	4.22	195	260	1.0	1.3	1.7	7.9	81.0	81.0	78.0	70.5	81.0	85.5		
			440	1710	4.19	280	370	1.0	1.3	1.5	9.5	79.0	81.5	81.0	59.5	72.5	79.5		
2	1.5	4	220	60	1710	8.38	190	210	3.5	4.5	5.9	29	82.5	82.0	79.5	70.5	81.0	85.5	0.00330
			380	1710	8.38	190	210	2.0	2.6	3.4	16.5	82.5	82.0	79.5	70.5	81.0	85.5		
			440	1730	8.28	265	300	2.1	2.5	3.0	20.0	80.5	82.5	82.0	58.0	71.5	79.0		
3	2.2	4	220	60	1710	12.3	190	225	4.7	6.2	8.1	43	84.0	83.5	81.0	75.0	84.0	87.5	0.00570
			380	1710	12.3	190	225	2.7	3.6	4.7	25	84.0	83.5	81.0	75.0	84.0	87.5		
			440	1730	12.2	270	320	2.8	3.5	4.3	29	82.0	84.0	83.5	62.5	75.0	81.5		
5	3.7	4	220	60	1700	20.8	185	215	7.1	10.0	13.5	71	86.5	85.5	82.0	78.5	86.0	88.0	0.01100
			380	1700	20.8	185	215	4.1	5.8	7.8	41	86.5	85.5	82.0	78.5	86.0	88.0		
			440	1730	20.4	265	310	4.3	5.4	6.8	49	85.0	86.0	85.0	66.5	78.0	83.5		
7.5	5.5	4	380	60	1720	30.6	200	245	5.9	8.1	10.7	60	89.0	89.0	87.5	79.0	86.5	89.0	0.01710
			440	1740	30.2	270	330	6.1	7.7	9.6	70	88.0	89.0	89.0	68.0	79.0	84.5		
10	7.5	4	380	60	1720	41.7	230	260	7.9	10.9	14.4	86	89.5	89.5	88.5	80.5	87.5	89.5	0.01110
			440	1740	41.2	325	360	7.9	10.2	12.8	101	88.5	89.5	89.5	70.0	81.0	86.0		
15	11	4	380	60	1730	60.8	200	220	11.1	15.7	20.9	116	90.0	90.0	89.0	83.5	88.5	90.0	0.03450
			440	1750	60.1	265	300	11.2	14.7	18.7	135	89.0	90.0	90.0	72.0	81.5	86.0		
20	15	4	380	60	1740	82.4	220	250	14.9	21.1	28.1	167	91.5	91.0	90.0	84.0	89.0	90.5	0.04460
			440	1750	81.9	295	335	14.9	19.6	24.9	193	90.5	91.5	91.0	73.0	82.5	86.5		

6 pole

60Hz

Rated		Poles	Volt	Hz	Rated	Torque			Current				Efficiency			Power Factor			Moment of Inertia J
Output					Speed	Rated	Start	Max	50%	75%	100%	Start	50%	75%	100%	50%	75%	100%	
HP	kW				(min ⁻¹)	(Nm)	(%)	(%)	(A)	(A)	(A)	(A)	(%)	(%)	(%)	(%)	(%)	(%)	(kg . m ²)
1/2	0.4	6	220	60	1130	3.38	195	250	1.4	1.6	1.9	7.8	71.5	74.0	72.5	54.0	67.5	76.5	0.002150
			380		1130	3.38	195	250	0.78	0.91	1.1	4.5	71.5	74.0	72.5	54.0	67.5	76.5	
			440		1140	3.35	275	355	0.87	0.95	1.1	5.4	67.5	72.5	74.0	44.5	57.0	66.5	
1	0.75	6	220	60	1120	6.40	180	215	2.4	2.9	3.6	13.7	73.0	74.0	71.5	56.5	69.5	77.5	0.004600
			380		1120	6.40	180	215	1.4	1.7	2.1	7.9	73.0	74.0	71.5	56.5	69.5	77.5	
			440		1140	6.29	240	290	1.6	1.7	2.0	9.1	70.0	73.5	74.0	45.5	58.5	68.0	
2	1.5	6	220	60	1110	12.9	180	210	3.8	4.8	6.4	28	80.0	79.5	75.5	64.5	76.0	81.5	0.00870
			380		1110	12.9	180	210	2.2	2.8	3.7	16.0	80.0	79.5	75.5	64.5	76.0	81.5	
			440		1130	12.7	240	280	2.4	2.8	3.4	19.0	77.5	79.5	79.0	52.5	66.0	74.0	
3	2.2	6	220	60	1120	18.8	220	280	5.2	6.8	8.5	47	83.0	83.5	81.0	66.5	78.0	83.5	0.01320
			380		1120	18.8	220	260	3.0	3.9	4.9	27	83.0	83.5	81.0	66.5	78.0	83.5	
			440		1140	18.4	315	375	3.3	3.8	4.6	32	81.0	83.0	83.0	54.5	68.0	76.5	
5	3.7	6	380	60	1100	32.1	170	210	4.5	6.1	8.1	40	86.0	84.5	81.5	72.5	81.5	85.0	0.02560
			440		1130	31.3	240	300	4.6	5.8	7.2	48	85.0	86.0	84.5	61.5	74.0	80.5	
7.5	5.5	6	380	60	1130	46.5	185	220	6.6	8.9	11.8	61	89.0	89.0	87.0	71.5	79.5	81.5	0.03430
			440		1150	45.7	265	320	6.8	8.5	10.5	72	88.0	89.0	88.5	60.0	71.5	77.5	
10	7.5	6	380	60	1150	62.3	205	305	8.6	11.5	14.8	98	89.0	89.5	88.0	74.0	83.5	87.5	0.05510
			440		1160	61.8	295	440	9.2	11.2	13.7	117	87.5	89.0	89.0	61.0	74.0	81.0	
15	11	6	380	60	1150	91.4	185	280	11.9	16.2	21.2	138	90.5	90.5	89.0	77.5	85.5	88.5	0.07270
			440		1160	90.6	270	405	12.3	15.4	19.2	164	89.0	90.0	90.0	66.0	78.0	83.5	

DRIP PROOF TYPE SPLIT-PHASE START SINGLE-PHASE MOTORS CAPACITOR START, CAPACITOR START CAPACITOR RUN 1/8 HP ~ 10 HP



Model:

xxHP or kW + Type-From + xP

Output

No of pole

SPECIFICATIONS

ITEM		SPECIFICATION		
STANDARD		JIS C4203, 4034, JEC-2137-2000		
RATING		CONTINUOUS [S1]		
INSULATION CLASS		E TYPE		
ENCLOSURES TYPE PROTECTION		ENCLOSURES		TYPE
		OPEN	DRIP	EFOU-KT, KR, KQ
		TYPE	PROOF	EFOUP-KT, KR, KQ
VOLTAGE, FREQUENCY		220V 50Hz		
TYPE OF CABLE		Made from high temperature resistance plastic (end of pole conduct electric current)		
NUMBER OF CABLE		4 WIRES (1/4-1/3 HP-KT, -KR, 2-10 HP-KQ) 3 WIRES (1/2-1.5 HP-KR, -KQ)		
COLOUR		Rigail gray (MUNSELL 8.9Y5.1/0.3)		
TRANSMISSION		DIRECT COUPLING OR BELT DRIVE		
ROTATION		CW (VIEW FROM MOTOR DRIVE END)		
ENVIRON- MENT	TEMPERATURE	-20°C ~ 40°C		
	HUMIDITY	Max 90% RH		
	ALTITUDE	Max 1,000 m		
	ESTABLISHMENT	IN DOOR		
ATMOSPHERE		NO CORROSIVE GAS, NO EXPLOSIVE GAS, NO STEAM, NO DEW, LITTLE DUST		

DIMENSIONS (in mm)

Type-From	Output (HP)	Fig. No	Ins. Class	Dimension in mm																	Weight (kg)						
				L	R	A	B	D	KL	J	H	C	F	E	N	M	G	Z	XB	S		W	U	T	Q	QK	QR
EFOU-KT	1/8	1	E	195.5	120	76	-	131	-	-	137	71 ⁰ _{-0.5}	45	56	110	150	3.2	7x26	45	14 ⁰ _{-0.001}	-	1	-	30	27	-	5.0
EFOU-KT	1/4	1	E	205	120	85	-	131	-	-	137	71 ⁰ _{-0.5}	45	56	110	150	3.2	7x26	45	14 ⁰ _{-0.001}	-	1	-	30	27	-	6.4
EFOU-KT	1/3	1	E	215	120	95	-	131	-	-	137	71 ⁰ _{-0.5}	45	56	110	150	3.2	7x26	45	14 ⁰ _{-0.001}	-	1	-	30	27	-	7.4
EFOUP-KT	1/2	2	E	256	140	116	97	145	-	-	153	80 ⁰ _{-0.5}	50	62.5	125	160	3.2	10x25	50	16 ^{+0.008} _{-0.003}	5	3	5	40	-	0.3	12
EFOU-KR	1/8	3	E	205.5	120	86	-	131	80	-	137	71 ⁰ _{-0.5}	45	56	110	150	3.2	7x26	45	14 ⁰ _{-0.001}	-	1	-	30	27	-	6.0
EFOU-KR	1/4	3	E	215.5	120	96	-	131	85	-	137	71 ⁰ _{-0.5}	45	56	110	150	3.2	7x26	45	14 ⁰ _{-0.001}	-	1	-	30	27	-	7.2
EFOU-KR	2/5	3	E	225.5	120	106	-	131	85	-	137	71 ⁰ _{-0.5}	45	56	110	150	3.2	7x26	45	14 ⁰ _{-0.001}	-	1	-	30	27	-	8.2
EFOU-KR	1/3	3	E	235.5	120	116	-	131	85	-	137	71 ⁰ _{-0.5}	45	56	110	150	3.2	7x26	45	14 ⁰ _{-0.001}	-	1	-	30	27	-	9.2
EFOUP-KR	1/2	4	E	256	140	116	97	144.5	79	35	169.5	80 ⁰ _{-0.5}	50	62.5	125	160	3.2	10x25	50	16 ^{+0.008} _{-0.003}	5	3	5	40	-	0.3	12
EFOUP-KR	1	4	E	274.5	158.5	116	115.5	162	89	40	192	90 ⁰ _{-0.5}	62.5	70	155	175	40	10x25	56	19 ^{+0.009} _{-0.004}	6	3.5	6	40	-	0.3	14
EFOUP-KQ	1.5	5	E	289	158.5	130.5	115.5	162	96	40	217	90 ⁰ _{-0.5}	62.5	70	155	175	40	10x25	56	19 ^{+0.009} _{-0.004}	6	3.5	6	40	-	0.3	18
EFOUP-KQ	2	6	B	397	193	204	129	208	174	45	247	100 ⁰ _{-0.5}	70	80	175	195	12.5	12	63	28 ^{+0.009} _{-0.004}	8	4	7	60	-	0.5	32
EFOUP-KQ	3	6	B	411	200	211	136	233	187	45	265	112 ⁰ _{-0.5}	70	95	175	224	14	12	70	28 ^{+0.009} _{-0.004}	8	4	7	60	-	0.5	39
EFOUP-KQ	5	7	B	496	258	238	173	269	236	45	263	132 ⁰ _{-0.5}	89	108	212	250	16	12	89	38 ^{+0.018} _{-0.002}	10	5	8	80	-	0.5	75
EFOUP-KQ	7.5	7	B	496	258	238	173	269	236	45	263	132 ⁰ _{-0.5}	89	108	212	250	16	12	89	38 ^{+0.018} _{-0.002}	10	5	8	80	-	0.5	82
EFOUP-KQ	10	7	B	496	258	238	173	269	236	45	263	132 ⁰ _{-0.5}	89	108	212	250	16	12	89	38 ^{+0.018} _{-0.002}	10	5	8	80	-	0.5	82

Shaft Dimension

Fig.1

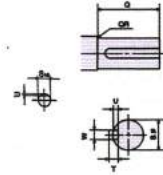
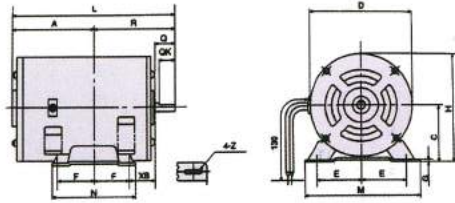

Fig.2

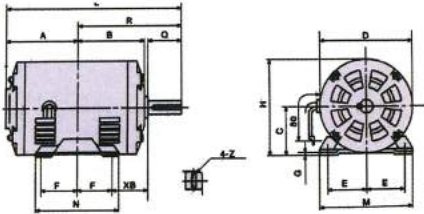

Fig.3

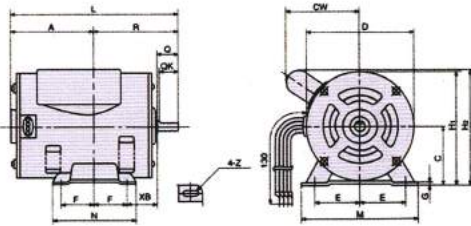

Fig.4

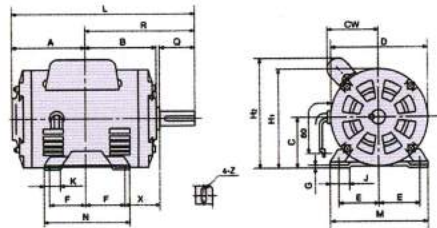

Fig.5

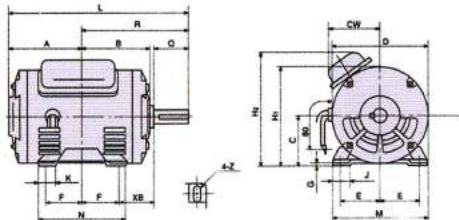

Fig.6

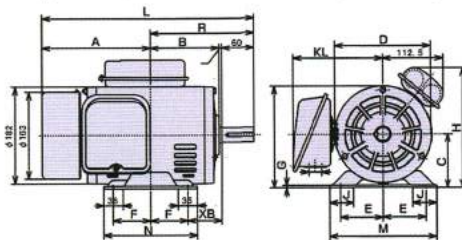
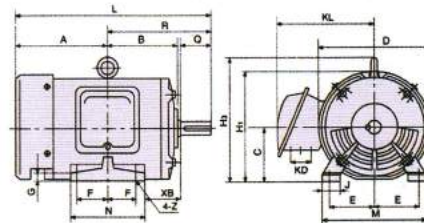

Fig.7



Type-From	Rated Output		INS. Class	Voltage (V)	Frequency (Hz)	Current (A)	Speed (min ⁻¹)
	HP	kW					
EFOU-KT	1/8	0.1	E	220	50	1.4	1450
EFOU-KT	1/4	0.2	E	220	50	2.3	1450
EFOU-KT	1/3	0.25	E	220	50	2.7	1430
EFOUP-KT	1/2	0.4	E	220	50	3.7	1400
EFOU-KR	1/8	0.1	E	220	50	2.2	1450
EFOU-KR	1/4	0.2	E	220	50	2.2	1450
EFOU-KR	2/5	0.3	E	220	50	2.6	1440
EFOU-KR	1/3	0.25	E	220	50	2.6	1440
EFOU-KR	1/2	0.4	E	220	50	3.4	1430
EFOU-KR	1	0.75	E	220	50	6.6	1410
EFOUP-KQ	1.5	1.1	B	220	50	10.0	1430
EFOUP-KQ	2	1.5	B	220	50	10.0	1430
EFOUP-KQ	3	2.2	B	220	50	13.0	1440
EFOUP-KQ	5	3.7	B	220	50	26.0	1450
EFOUP-KQ	7.5	5.5	B	220	50	33.0	1450
EFOUP-KQ	10	7.5	B	220	50	42.0	1440

Unique construction models



Resilient Base Mounting Model



Enclosure Type [TFEC Type]

Construction as total enclosure with fan cooled.

- Model : 0.4, 0.55, 0.75kW TFO-KQ 4P



- Model : 0.4kW TFO-KR 4P

How to order the motors.

Model indication (Example):

xxHP (or kW) TFO-K(KK) xP IP55 + Voltage/Hz + Optional Spec.

Output Type No of pole

Please specify the model indication upon your inquiry when request.

Example : 3HP (or 2.2kW), 4 pole, Foot Mount, Protection class IP55, Voltage 380V 50Hz

For new installation

3HP (or 2.2kW) TFO-K 4P IP55 380V 50Hz

For replacement

3HP (or 2.2kW) TFO-K 4P IP55 380V 50Hz + **MFG No.**

MFG No. (Manufacturing No.) is also need to check specifications

Model Explanation

Three-Phase

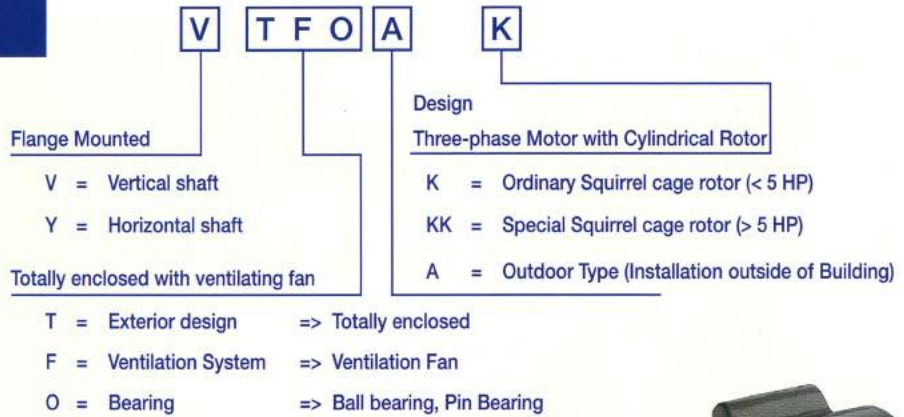

Single-Phase

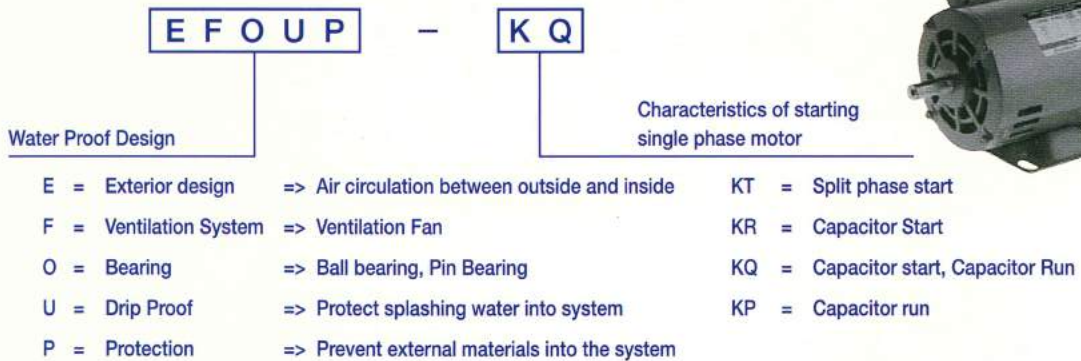

kW and HP comparable table

HP	1	2	3	5	7.5	10	15	20	25	30	40	50	60	75	100	120	150	175
kW	0.75	1.5	2.2	3.7	5.5	7.5	11	15	18.5	22	30	37	45	55	75	90	110	132

Other Line-up



Premium High-Efficiency Motors

Equivalent to IE3 class



High-Efficiency Motors

Equivalent to IE2 class



Brake Motors

On Brake & Off Brake model

Brake model : HBA, FA, NA

Output : 0.2~30kW (in case 4 pole)



Gear Motors

GA/GH-series (For General load)

Output : 0.2~11kW 1/5~1/100



High-Pressure Blowers

Vortex Blower

E-series (Large air flow type)

G-series (High-pressure type)

DN-series (General type)



Water Pumps

JD Type : Circulation Pumps

JL Type : In-line Pumps

Output : 0.25kW~11kW

Inverters (For variable speed operation)

Powerful model

WJ200 Series

Pursuing the Ideal Compact Inverter



SJ700 Series

High performance with Many useful Functions and, yet User Friendly



General Purpose model

NE-S1 series

อินเวอร์เตอร์รุ่นประหยัด



X200 Series

Simple, Trip-suppression and Eco-friendly Compact Inverter



SJ700B Series

Inverter designed for fans & pumps plus conveyors





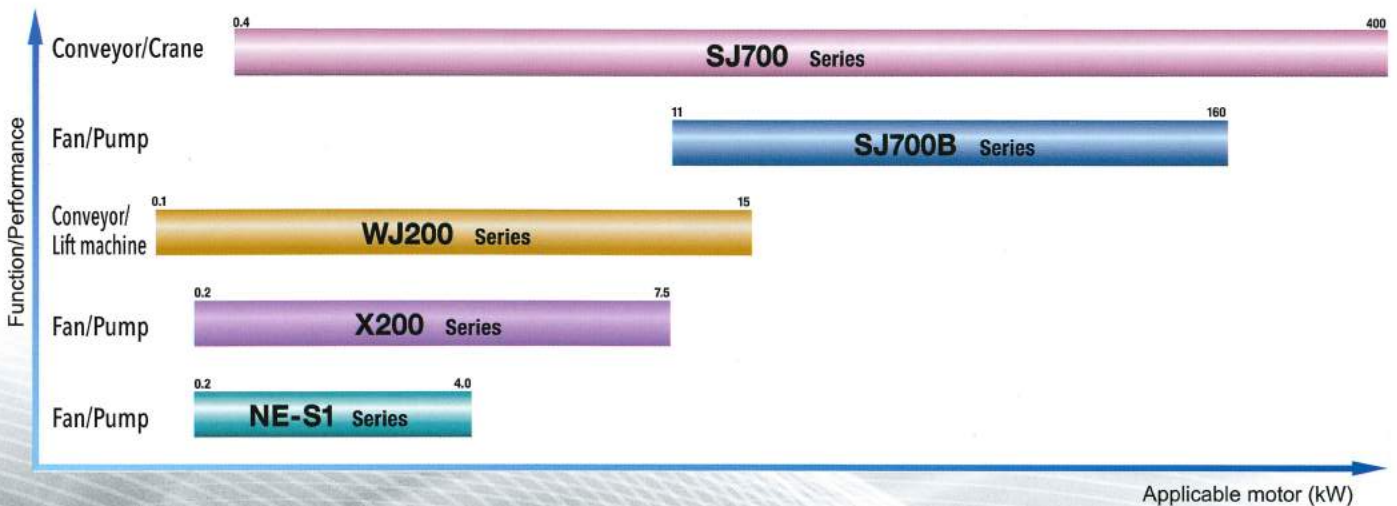

Model	kW (HP)	0.1 (1/8)	0.2 (1/4)	0.4 (1/2)	0.55 (3/4)	0.75 (1)	1.1 (1.5)	1.5 (2)	2.2 (3)	3 (4)	3.7 (5)	4 (5)	5.5 (7.5)	7.5 (10)	11 (15)	15 (20)	18.5 (25)	22 (30)	30 (40)	37 (50)	45 (60)	55 (75)	75 (100)	90 (125)	110 (150)	132 (175)	150 (200)	160 (220)	185 (250)	220 (300)	315 (400)	400 (500)			
NE-S1	1-phase 200V class																																		
	3-phase 200V class																																		
WJ200	1-phase 100V class																																		
	1-phase 200V class																																		
	3-phase 200V class																																		
	3-phase 400V class																																		
X200*	1-/3-phase 200V class																																		
	3-phase 200V class																																		
	3-phase 400V class																																		
SJ700	3-phase 200V class																																		
	3-phase 400V class																																		
SJ700B	3-phase 400V class																																		

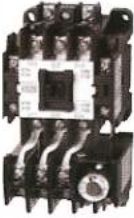

Switches (Contactors & Breakers)

Electromagnetic Contactors

	Electromagnetic Contactors		Electromagnetic Contactors			
			Without Enclosure		With Enclosure	
Non-reversible Type		HS <input type="text"/> <input type="text"/> 8 - 50 frame		HS <input type="text"/> <input type="text"/> -T 8 - 50 frame		SHS <input type="text"/> <input type="text"/> -T 10 - 50 frame
		H <input type="text"/> <input type="text"/> 65C - 800C frame		H <input type="text"/> <input type="text"/> -T 65C - 600C frame		SH <input type="text"/> <input type="text"/> -T 65C - 600C frame
Reversible Type [20 - 800C frame (provided mechanical interlock)]		HS <input type="text"/> <input type="text"/> -R 10 - 50 frame		HS <input type="text"/> <input type="text"/> -RT 10 - 50 frame		SHS <input type="text"/> <input type="text"/> -RT 10 - 50 frame
		H <input type="text"/> <input type="text"/> -R 65C - 800C frame		H <input type="text"/> <input type="text"/> -RT 65C - 600C frame		SH <input type="text"/> <input type="text"/> -RT 65C - 600C frame

Contactor Relays

XS4 	X <input type="text"/>  3 - 8 contacts (5 types)
---	--

Thermal Overload Relays

 12 - 600A (9 types)	TR <input type="text"/> <input type="text"/> - <input type="text"/> (Electromagnetic Switches with Thermal Overload Relay) H <input type="text"/> <input type="text"/> -T H <input type="text"/> <input type="text"/> -TK with 25 Thermal Overload Relay
--	---

DC Operated Electromagnetic Relays

 10 - 800C frame	H <input type="text"/> <input type="text"/> -G
--	---

Latched Electromagnetic Relays

 10 - 600C frame	H <input type="text"/> <input type="text"/> -L
--	---

Heavy Load Electromagnetic Relays

 10 - 200N frame	H <input type="text"/> <input type="text"/> -H
--	---

Fuse-Free Breaker

Standard Breaker	Economical Breaker	High Interrupting Capacity Breaker
 Fundamental F series 30A-4000A Frame	 Small S series 30A-800A Frame	 Current Limiting L series 50A-800A Frame

Air-Circuit Breaker

AKN, AKS, AKH Series
 630 - 6,300 AF

Memo



Technical Managements

Special Instruction

[Inspect the machine before use]

Please inspect the following area before turning on the switch ;

- Inspect if the following area are in ground wiring and insulation wiring,
- Inspect preventive apparatus and control circuit if they are working properly.
- Is the value of insulation resistance less than 1MΩ or not.
- Inspect if machine installation (direct belt) is correctly done.

[Precaution during use]

- Should be careful in loading capacity and frequency in turning on the machine. Machine should not be on for a long period of time.
- If the motor rotates in a wrong direction, in case of three-phase motor, swap the two wires. In case of single-phase motor, re-wiring following the connection circuit.
- Voltage Amp should be within a correct limitation.
 - Is voltage amp correct as indicated in the instruction manual ?
 - Is there any balance in voltage amp for three-phase line ?
 - Is the electrical distributed power higher than the indicated limitation ? It should be adjusted to an appropriate loading capacity.
 - Inspect to make sure there is no vibration sound and abnormal heating.

Outdoor Installation

- Use a motor that has a totally enclosed with cooling fan and can be placed outside a building. The motor can be installed outside because it can prevent any water droplets in between core structures. The terminal box should have water protection and seal that can prevent water coming into lead wire connection. Insulated wires can tolerate humidity and seal that can prevent water seeping into lead wire connection.
- You can connect wires in steel tubed connection on the side (For wire connection of motor outside the building, you should follow the instructional pictures in preventing rain from iron pipe seeping into the terminal box).
- General type of totally enclosed motor with cooling fan is IP44 class. If installing in high dust area, you can use IP54 class. In case having water injection into a machine, you can use IP55 class.

Maintenance

[Daily basis]

- Surrounding environment :
Inspect the temperature around the entire machine, humidity, dust, gas and ventilation system.
- Working essentials :
Inspect the electric distribution (loading capacity), frequency and voltage amp.
- Loading condition and machine connection :
Inspect the tension of connecting belt.
- Condition around machine connection area :
Vibration and sound for making sure if it's working properly.

[Periodic basis]

- Should be inspected
Bearings, insulating stator (no less than 1MΩ, looseness of any bolt and nut, colors, etc. Including inspection of motor condition if it's working correctly at least once a year.

Installation Example

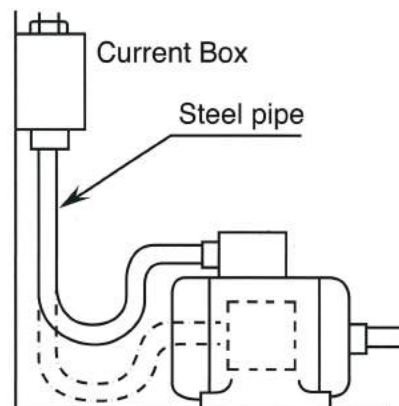

Hitachi Asia, Ltd.
Hitachi Industrial Technology (Thailand), Ltd.

For furthermore information, please contact to nearest sales representative.

Version No. 032016